

FURNITURE  
COLLECTIONS

**BUDRI**  
DESIGN

# INDEX

## VASES

### PATRICIA URQUIOLA

|                                      |    |
|--------------------------------------|----|
| <b>NEW</b> SORBETTOSO TABLE ORNAMENT | 9  |
| RABBET RAINBOW VASES                 | 11 |
| ALGAS VASE                           | 13 |
| ORILLA ONYX VASE                     | 15 |
| ORILLA CIPOLLINO VASE                | 17 |
| PAPIRO VASES                         | 19 |
| RABBET VASES                         | 21 |
| TRICOT VASES                         | 23 |
| TRICOT VASES                         | 25 |
| EARTHQUAKE VASES                     | 27 |
| Y-TUBE VASES                         | 29 |
| Y-TUBE VASES                         | 31 |

### CRISTINA CELESTINO

|                    |    |
|--------------------|----|
| ANNA VASE          | 35 |
| LOLLO VASE         | 37 |
| MINA VASE          | 39 |
| ORIANA VASE        | 41 |
| SOPHIA VASE        | 43 |
| RITA VASE          | 45 |
| GAE VASE           | 47 |
| LEA VASE           | 49 |
| FRIDA TRAY         | 51 |
| COCO PRECIOUS BOX  | 53 |
| GRACE PRECIOUS BOX | 55 |

### GWENAEL NICOLAS

|             |    |
|-------------|----|
| WANDO VASES | 59 |
| VASUM       | 61 |

## LIVING TABLES

### PATRICIA URQUIOLA

|   |     |
|---|-----|
| <b>NEW</b> BIG PIERCE LIVING TABLE      | 67  |
| <b>NEW</b> PIERCE LIVING TABLE          | 69  |
| <b>NEW</b> MAREA LIVING TABLE - AQUAREL | 71  |
| ARCHITEXTURE LIVING TABLE O1            | 73  |
| ARCHITEXTURE LIVING TABLE O2            | 75  |
| ARCHITEXTURE LIVING TABLE O3            | 77  |
| MAREA LIVING TABLE                      | 79  |
| ORILLA LIVING TABLE                     | 81  |
| CONE TABLE - WALLPAPER                  | 83  |
| CONE TABLE BLUE                         | 85  |
| AMELIE TABLE                            | 87  |
| PAPIRO BISCUIT TABLE                    | 89  |
| BON BON TABLE                           | 91  |
| BALLON TABLE                            | 93  |
| EARTHQUAKE TABLE                        | 95  |
| CANYON TABLE YELLOW                     | 97  |
| CANYON TABLE PINK                       | 99  |
| MARBLELACE BISCUIT TABLE                | 101 |

### GWENAEL NICOLAS

|                      |     |
|----------------------|-----|
| BAKODO LIVING TABLE  | 105 |
| INITIUM LIVING TABLE | 107 |

### MAARTEN DE CEULAER

|                          |     |
|--------------------------|-----|
| RECTANGULAR LIVING TABLE | 111 |
| OVAL LIVING TABLE        | 113 |
| ROUND LIVING TABLE       | 115 |
| SQUARE LIVING TABLE      | 117 |

## COFFEE & SIDE TABLES

### PATRICIA URQUIOLA

|   |     |
|---|-----|
| <b>NEW</b> GELATOSO COFFEE TABLE            | 123 |
| <b>NEW</b> ORIGAMI AMETHYST COFFEE TABLE    | 125 |
| <b>NEW</b> ORIGAMI MIMOSA COFFEE TABLE      | 127 |
| <b>NEW</b> ORIGAMI QUEEN ELIZABETH II CT    | 129 |
| <b>NEW</b> ORIGAMI INCISO PINK COFFEE TABLE | 131 |
| ARCHITEXTURE COFFEE TABLE O4                | 133 |
| ARCHITEXTURE COFFEE TABLE O5                | 135 |
| ARCHITEXTURE SIDE TABLES                    | 137 |
| MAREA COFFEE TABLES                         | 139 |
| PAPIRO COFFEE TABLES                        | 141 |
| RABBET COFFEE TABLES                        | 143 |
| ORIGAMI RAINBOW S COFFEE TABLE              | 147 |
| ORIGAMI RAINBOW L COFFEE TABLE              | 149 |
| ORIGAMI COFFEE TABLES MONO                  | 151 |
| ORIGAMI COFFEE TABLES BICOLOR               | 153 |
| ORIGAMI STRIPES COFFEE TABLES               | 155 |
| NAT FUSE COFFEE TABLES                      | 157 |
| NAT FUSE COFFEE TABLES                      | 159 |
| ZIGZAG COFFEE TABLES                        | 161 |
| BARRETTA COFFEE TABLES                      | 163 |

### MAARTEN DE CEULAER

|                         |     |
|-------------------------|-----|
| SQUARE LOW COFFEE TABLE | 167 |
|-------------------------|-----|

### GWENAEL NICOLAS

|                                 |     |
|---------------------------------|-----|
| SHIKAKU COFFEE TABLE            | 171 |
| TRITTICO-SAN COFFEE TABLE       | 173 |
| BAKODO SIDE TABLES              | 175 |
| CALEIDOS COFFEE TABLES          | 177 |
| IUNGO SIDE TABLE                | 179 |
| CONTINUUS SIDE TABLES AND SHELF | 181 |

### SONJA VIZZINI

|                             |     |
|-----------------------------|-----|
| VIRIL, VERIDIQUE, VENERABLE | 185 |
|-----------------------------|-----|

## CONSOLLE

### PATRICIA URQUIOLA

|                       |     |
|-----------------------|-----|
| ARCHITEXTURE CONSOLLE | 191 |
| MAREA CONSOLLE        | 193 |
| ORILLA CONSOLLE       | 195 |

### GWENAEL NICOLAS

|                    |     |
|--------------------|-----|
| SUBARASHI CONSOLLE | 199 |
| SETIS CONSOLLE     | 201 |

## CARPETS

### PATRICIA URQUIOLA

|                 |     |
|-----------------|-----|
| AGATA CARPET    | 207 |
| NAT FUSE CARPET | 209 |

## SEATS

### PATRICIA URQUIOLA

|                           |     |
|---------------------------|-----|
| SEMICIRCLES BENCH & STOOL | 215 |
| FACHIRO BENCH             | 217 |
| ALGAE BENCH               | 219 |

## SIDEBOARDS

### GWENAEL NICOLAS

|                      |     |
|----------------------|-----|
| EXQUISITUS SIDEBOARD | 225 |
|----------------------|-----|

## BOOKCASES

### PATRICIA URQUIOLA

|                    |     |
|--------------------|-----|
| BOOKCASE DISPLAY   | 231 |
| BOOKCASE DISPLAY   | 233 |
| SHELF WALL DISPLAY | 235 |

### GWENAEL NICOLAS

|               |     |
|---------------|-----|
| FLUO BOOKCASE | 239 |
|---------------|-----|

## OTHERS

### PATRICIA URQUIOLA

|                            |     |
|----------------------------|-----|
| <b>NEW</b> PARAVENT SCREEN | 245 |
| WASH BASIN                 | 247 |

### GWENAEL NICOLAS

|                    |     |
|--------------------|-----|
| ESSENTIAL DIFFUSER | 251 |
| GLOBUS CHANDELIER  | 253 |
| LIQUIDUS MIRROR    | 255 |

### VALERIO COMETTI

|        |     |
|--------|-----|
| FERMAT | 259 |
|--------|-----|

## LIGHTING

### GWENAEL NICOLAS

|                   |     |
|-------------------|-----|
| WANDO FLOOR LAMP  | 265 |
| GUTTA LAMP        | 267 |
| THINIUM WALL LAMP | 269 |

### CRISTINA CELESTINO

|            |     |
|------------|-----|
| ALICE LAMP | 273 |
|------------|-----|

## ABOUT BUDRI

|             |     |
|-------------|-----|
| ABOUT BUDRI | 277 |
|-------------|-----|



# PATRICIA URQUIOLA

# SORBETTOSO TABLE ORNAMENT

AQUAREL COLLECTION



SORBETTOSO TABLE ORNAMENT

DESCRIPTION

DIMENSIONS

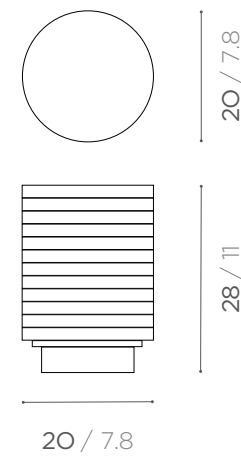

CYLINDRICAL TABLE ORNAMENT COMPOSED OF RINGS OF IRANIAN WHITE ONYX WATERCOLORED IN PEACH, LIME, APRICOT, CORAL TONES.

BASE IN ROMAN CLASSIC TRAVERTINE, NATURAL PORE, SANDBLASTED FINISH.

**20 x h 28 cm**  
7.8 x h 11 inch  
4 kg / 8,82 lb

# RABBIT RAINBOW VASES

RABBIT COLLECTION



RABBIT RAINBOW VASES

DESCRIPTION

DIMENSIONS

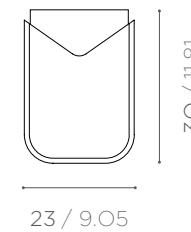

**RR 03**  
VASE IN BIANCO LASA AND ACID GREEN METAL CYLINDER.

**ø 23 x h 30 cm**  
ø 9.05 x h 11.8 inch  
6,5 kg / 14.3 lb

RABBIT RAINBOW VASES

DESCRIPTION

DIMENSIONS

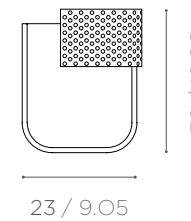

**RR 02**  
VASE IN BIANCO LASA AND BLACK METAL GRID.

**ø 23 x h 32 cm**  
ø 9.05 x h 12.6 inch  
7,8 kg / 17.2 lb

**RR 04**  
VASE IN BIANCO LASA AND CHERRY METAL GRID.

**ø 23 x h 32 cm**  
ø 9.05 x h 12.6 inch  
7,8 kg / 17.2 lb

RABBIT RAINBOW VASES

DESCRIPTION

DIMENSIONS

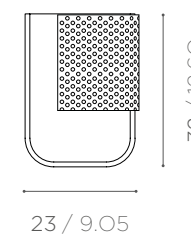

**RR 01**  
VASE IN BIANCO LASA AND BLUE CARAIBI METAL GRID.

**ø 23 x h 32 cm**  
ø 9.05 x h 12.6 inch  
7,8 kg / 17.2 lb

**RR 05**  
VASE IN BIANCO LASA AND INDIGO BLUE METAL GRID

**ø 23 x h 32 cm**  
ø 9.05 x h 12.6 inch  
7,8 kg / 17.2 lb

# ALGAS VASE

AGUA COLLECTION



ALGAS VASE

DESCRIPTION

DIMENSIONS

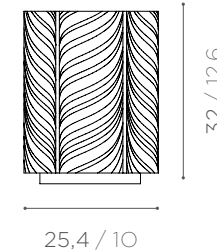

ALGAS VASE, OF HEXAGONAL SHAPE, REALIZED WITH ARTISTIC INLAYS OF PRECIOUS MARBLES: VERDE ALPI, VERDE CIPOLLINO, VERDE ACQUAMARINA, BIANCO SIVEC AND FUCHSIA RESIN INLAYS. THE BOTTOM OF THE VASE IS IN VERDE ACQUAMARINA.

**25,4 x 22,4 x h 32 cm**  
10 x 8.6 x h 12.6 inch  
7,7 kg / 15.4 lb

# ORILLA ONYX VASE

AGUA COLLECTION

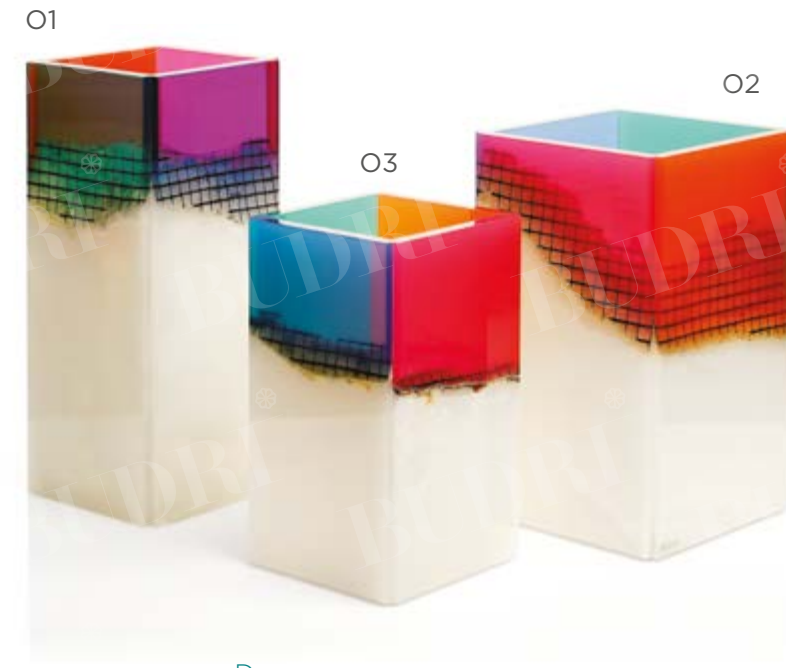

ORILLA VASES ONYX

DESCRIPTION

DIMENSIONS

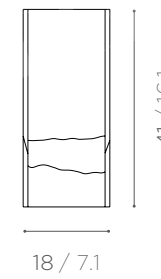

ORILLA VASE ONYX O1

ORILLA VASE IN WHITE IRANIAN ONYX, BLACK MESH SCAR AND EMERALD GREEN, RED, FUCHSIA AND INDIGO BLUE RESIN.

**18 x 18 x h 41 cm**  
7.1 x 7.1 x h 16.1 inch  
11,6 kg / 25.5 lb

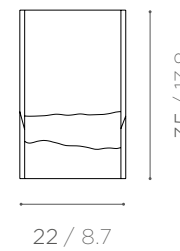

ORILLA VASE ONYX O2

ORILLA VASE IN WHITE IRANIAN ONYX, BLACK MESH SCAR AND EMERALD GREEN, RED, FUCHSIA AND INDIGO BLUE RESIN.

**22 x 22 x h 35 cm**  
8.7 x 8.7 x h 13.8 inch  
12 kg / 26.5 lb

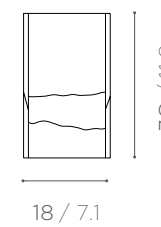

ORILLA VASE ONYX O3

ORILLA VASE IN WHITE IRANIAN ONYX, BLACK MESH SCAR AND EMERALD GREEN, RED, FUCHSIA AND INDIGO BLUE RESIN.

**18 x 18 x h 30 cm**  
7.1 x 7.1 x h 11.8 inch  
6,3 kg / 14 lb



# ORILLA CIPOLLINO VASE

AGUA COLLECTION

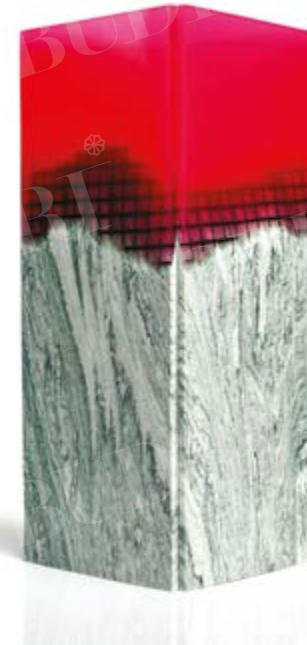

ORILLA VASES CIPOLLINO

DESCRIPTION

DIMENSIONS

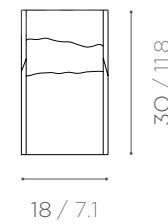

ORILLA VASE CIPOLLINO GREEN

ORILLA VASE IN VERDE CIPOLLINO MARBLE, BLACK MESH SCAR AND EMERALD GREEN RESIN.

**18 x 18 x h 30 cm**  
7.1 x 7.1 x h 11.8 inch  
5 kg / 11 lb

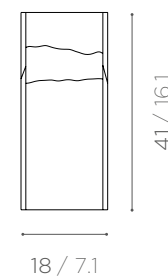

ORILLA VASE CIPOLLINO RED

ORILLA VASE IN VERDE CIPOLLINO MARBLE, BLACK MESH SCAR AND RED RESIN.

**18 x 18 x h 41 cm**  
7.1 x 7.1 x h 16.1 inch  
10,2 kg / 22.5 lb

# PAPIRO VASES

PAPIRO COLLECTION



O1



O2

PAPIRO VASES

DESCRIPTION

DIMENSIONS

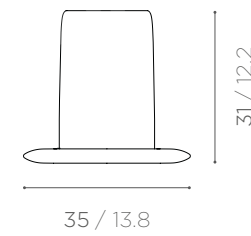

PAPIRO VASE O1

VASE IN STATUARIO ALTISSIMO, MATTE FINISHING.

**vase ø 18 x h 31 cm**

VASE ø 7.1 x h 12.2 inch

**PLATE ø 35 x h 2 cm**

PLATE ø 13.8 x h 0.8 inch

14,1 kg / 31 lb

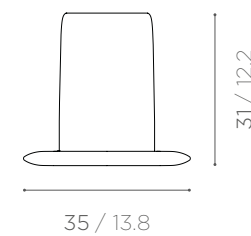

PAPIRO VASE O2

VASE IN WHITE ONYX, MATTE FINISHING.

**vase ø 18 x h 31 cm**

VASE ø 7.1 x h 12.2 inch

**PLATE ø 35 x h 2 cm**

PLATE ø 13.8 x h 0.8 inch

14,1 kg / 31 lb

# RABBET VASES

## RABBET COLLECTION

O1



O2



O3



O4



RABBET VASE O1

DESCRIPTION

DIMENSIONS



VASE IN BIANCO CARRARA AND COPPER COLOURED METAL CYLINDER.

Ø 23 x h 30 cm  
Ø 9.05 x h 11.8 inch  
6,5 kg / 14.3 lb

RABBET VASE O2

DESCRIPTION

DIMENSIONS

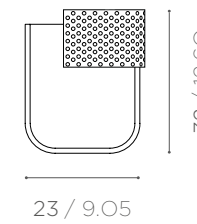

VASE IN AZUL MACAUBAS AND COPPER COLOURED METAL GRID.

Ø 23 x h 32 cm  
Ø 9.05 x h 12.6 inch  
7,8 kg / 17.2 lb

RABBET VASE O3

DESCRIPTION

DIMENSIONS

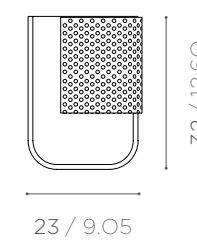

VASE IN ROSA PORTOGALLO AND COPPER COLOURED METAL GRID.

Ø 23 x h 32 cm  
Ø 9.05 x h 12.6 inch  
7,8 kg / 17.2 lb

RABBET VASE O4

DESCRIPTION

DIMENSIONS

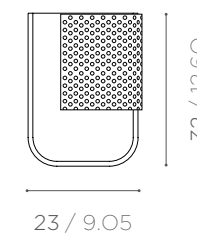

VASE IN BIANCO LASA COVELANO AND COPPER COLOURED METAL GRID.

Ø 23 x h 32 cm  
Ø 9.05 x h 12.6 inch  
7,8 kg / 17.2 lb

# TRICOT VASES

EARTHQUAKE 5.9 COLLECTION

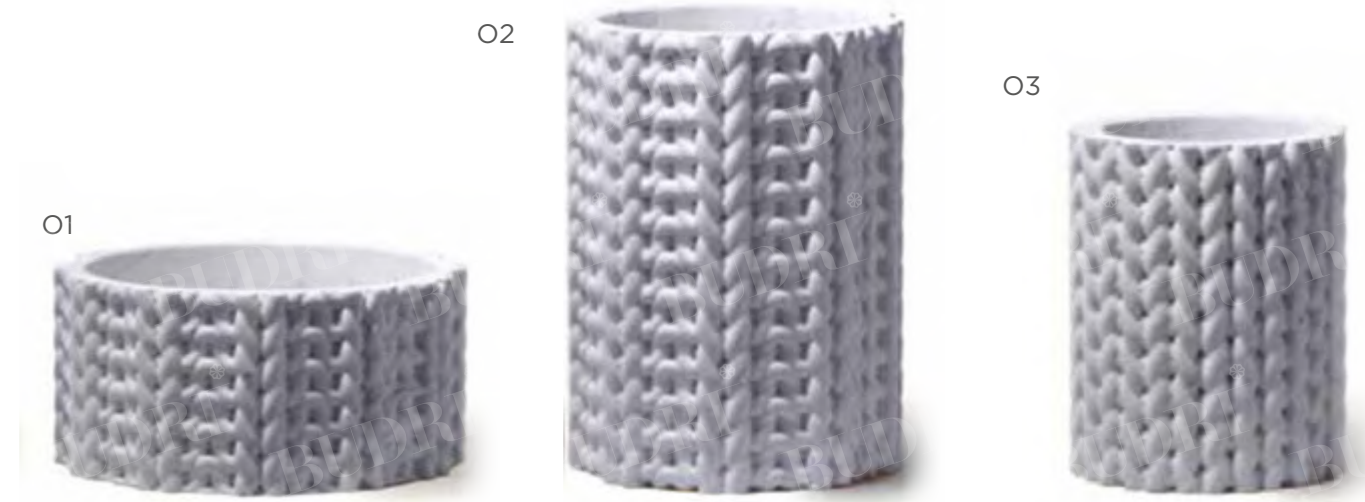
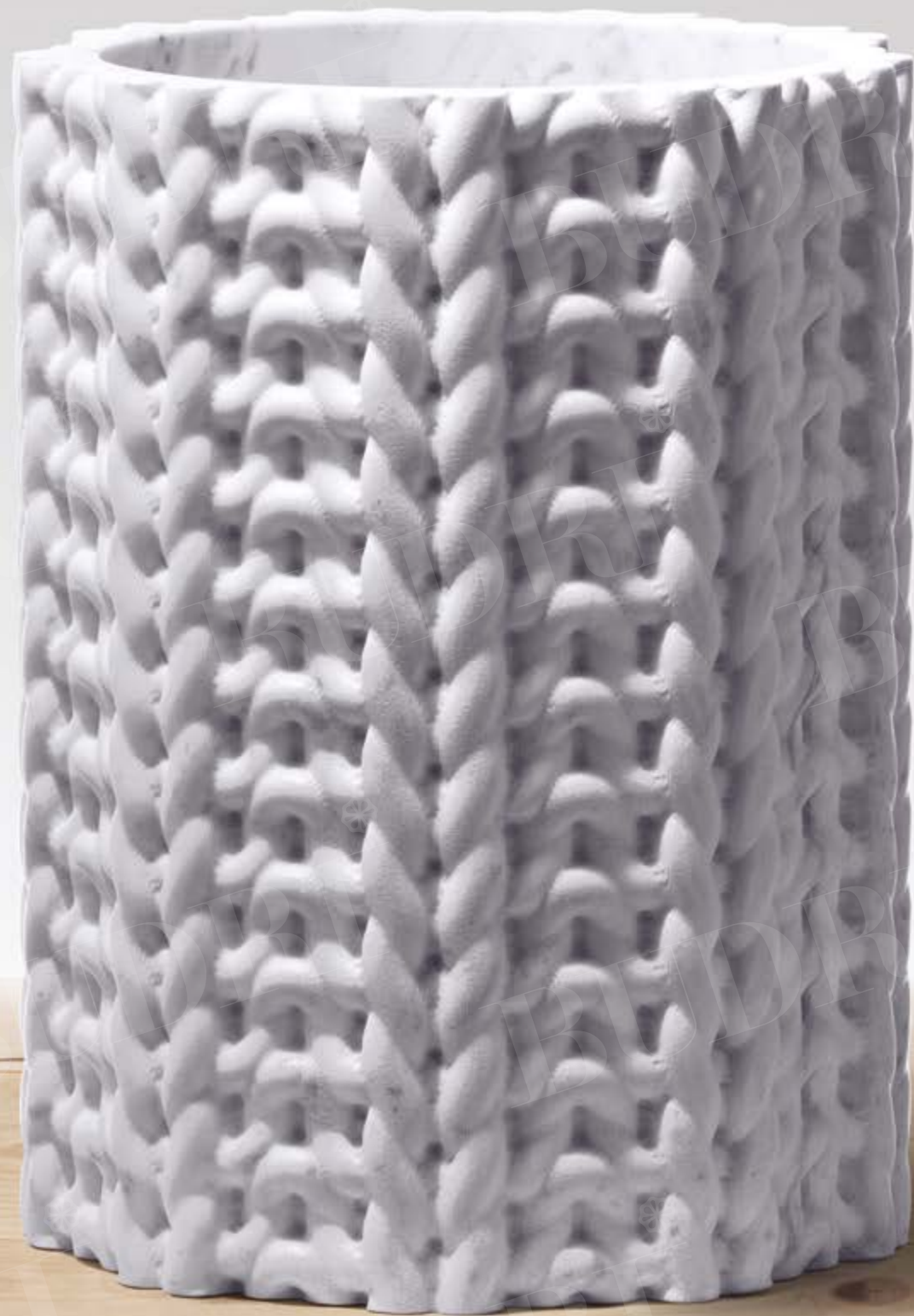

TRICOT VASES

DESCRIPTION

DIMENSIONS

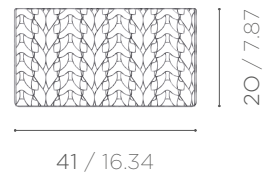

**TRICOT VASE O1**  
 VASE IN BIANCO CARRARA MARBLE, WITH TRICOT "RIB" TEXTURE.

**ø 41,5 x h 20 cm**  
 ø 16.3 x h 7.9 inch  
 27 kg / 59.6 lb

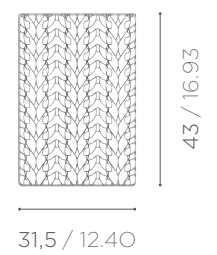

**TRICOT VASE O2**  
 VASE IN BIANCO CARRARA MARBLE, WITH TRICOT "RIB" TEXTURE.

**ø 31,5 x h 43 cm**  
 ø 12.4 x h 16.9 inch  
 32,5 kg / 71.6 lb

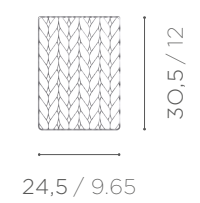

**TRICOT VASE O3**  
 VASE IN BIANCO CARRARA MARBLE, WITH TRICOT "KNIT" TEXTURE.

**ø 24,5 x h 30,5 cm**  
 ø 9.5 x h 12 inch  
 16,7 kg / 36.8 lb

# TRICOT VASES

EARTHQUAKE 5.9 COLLECTION



O1



O2



TRICOT VASES

DESCRIPTION

DIMENSIONS



**TRICOT VASE O1**  
 VASE IN ROSA PORTOGALLO MARBLE,  
 WITH TRICOT "KNIT" TEXTURE.

**ø 24,5 x h 30,5 cm**  
 ø 9.5 x h 12 inch  
 16,7 kg / 36.8 lb

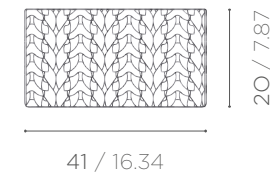

**TRICOT VASE O2**  
 VASE IN BIANCO CARRARA MARBLE,  
 WITH TRICOT "RIB" TEXTURE.

**ø 41,5 x h 20 cm**  
 ø 16.3 x h 7.9 inch  
 27 kg / 59.6 lb

# EARTHQUAKE VASES

EARTHQUAKE 5.9 COLLECTION



01



02



EARTHQUAKE VASES

DESCRIPTION

DIMENSIONS

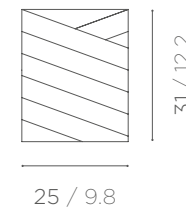

VASE 01

INLAID VASE IN FIOR DI PESCO, ROSA PORTOGALLO, GIALLO SIENA, BIANCO LASA MARBLES.

**25 x 25 x h 31 cm**  
9.8 x 9.8 x h 12.2 inch  
8,1 kg / 17.9 lb



VASE 02

INLAID VASE IN FIOR DI PESCO, ROSA PORTOGALLO, GIALLO SIENA, BIANCO LASA MARBLES.

**20 x 20 x h 40 cm**  
7.9 x 7.9 x h 15.7 inch  
7,9 kg / 17.4 lb

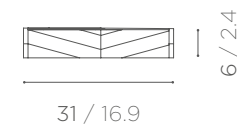

TRAY

INLAID VASE IN FIOR DI PESCO, ROSA PORTOGALLO, GIALLO SIENA, BIANCO LASA MARBLES.

**43 x 31 x h 6 cm**  
16.9 x 12.2 x h 2.4 inch  
5 kg / 11 lb

# Y-TUBE VASES

NAT|F|USE COLLECTION



O1



O2



## Y-TUBE VASES

### DESCRIPTION

### DIMENSIONS

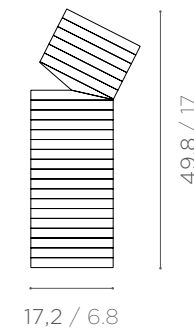

#### Y-TUBE VASE O1

INLAID VASE IN PRECIOUS MARBLES, ONYX AND SODALITE.

ø 17,2 x h 49,8 cm  
ø 6.8 x h 17 inch  
5,1 kg / 11.2 lb

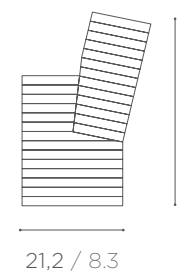

#### Y-TUBE VASE O2

INLAID VASE IN PRECIOUS MARBLES, ONYX AND SODALITE.

ø 21,2 x h 39,7 cm  
ø 8.3 x h 15.6 inch  
5,4 kg / 11.9 lb

# Y-TUBE VASES

NAT|F|USE COLLECTION



O3



O4



## Y-TUBE VASES

## DESCRIPTION

## DIMENSIONS

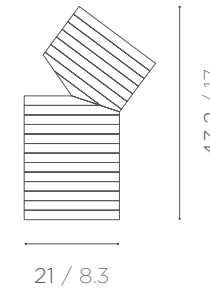

### Y-TUBE VASE O3

INLAID VASE IN PRECIOUS MARBLES,  
ONYX AND SODALITE.

**ø 21 x h 43,2 cm**  
ø 8.3 x h 17 inch  
5,8 kg / 12.8 lb

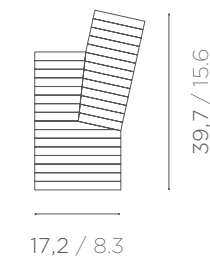

### Y-TUBE VASE O4

INLAID VASE IN PRECIOUS MARBLES,  
ONYX AND SODALITE.

**ø 21,2 x h 39,7 cm**  
ø 8.3 x h 15.6 inch  
5,4 kg / 11.9 lb



# CRISTINA CELESTINO



# ANNA VASE

BANGLE COLLECTION



ANNA VASE

DESCRIPTION

DIMENSIONS

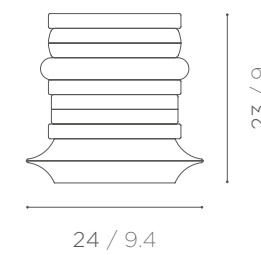

VASE WITH BANGLES OF DIFFERENT COLORS AND SHAPES, REALIZED IN NERO ASSOLUTO, GREEN ONYX, RAIN FOREST GREEN AND GIALLO NOCE.

**24 x h 23 cm**  
9.4 x h 9 inch  
8,5 kg / 18.7 lb



CRISTINA CELESTINO

VASES

# LOLLO VASE

BANGLE COLLECTION



LOLLO VASE

DESCRIPTION

DIMENSIONS

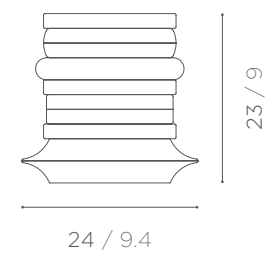

VASE WITH BANGLES OF DIFFERENT COLORS AND SHAPES, REALIZED IN NERO ASSOLUTO, VERDE MING, RAIN FOREST GREEN, GIALLO NOCE AND ONICE MIELE.

**24 x h 23 cm**  
9.4 x h 9 inch  
8,5 kg / 18.7 lb



# MINA VASE

BANGLE COLLECTION



MINA VASE

DESCRIPTION

DIMENSIONS

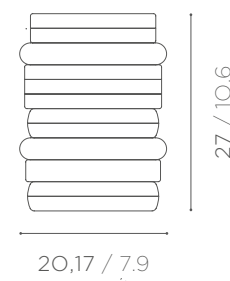

VASE WITH BANGLES OF DIFFERENT COLORS AND SHAPES, REALIZED WITH NERO ASSOLUTO, ROSSO BAROCCO, RAIN FOREST GREEN, GIALLO NOCE AND ONICE MIELE.

**20 x h 27 cm**  
7.9 x h 10.6 inch  
9,2 kg / 20.3 lb



# ORIANA VASE

BANGLE COLLECTION



ORIANA VASE

DESCRIPTION

DIMENSIONS

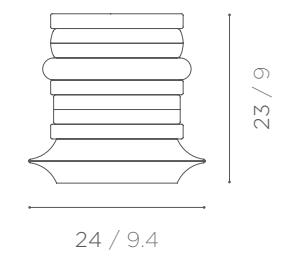

MONOCHROMATIC VASE IN IRANIAN WHITE ONYX AND BIANCO CARRARA WITH BANGLES OF DIFFERENT SHAPES.

**24 x h 23 cm**  
9.4 x h 9 inch  
8 kg / 17.6 lb



# SOPHIA VASE

BANGLE COLLECTION



SOPHIA VASE

## DESCRIPTION

## DIMENSIONS

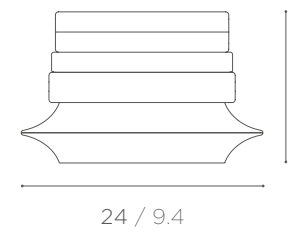

BANGLE POT IN NERO ASSOLUTO, ONICE MIELE, EMERALD GREEN AND ROSSO BAROCCO, MADE OF 4 BANGLES OF DIFFERENT SHAPES.

**24 x h 15 cm**  
9.4 x h 5.9 inch  
6 kg / 13.2 lb



# RITA VASE

BANGLE COLLECTION



RITA VASE

DESCRIPTION

DIMENSIONS

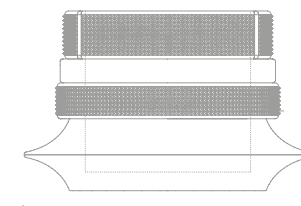

24 / 9.4

15 / 5.9

BANGLE POT IN BIANCO STATUARIO AND EMERALD GREEN, MADE OF 4 BANGLES OF DIFFERENT SHAPES. THE VERY 'DIAMOND' TEXTURE IN THE MIDDLE AND UPPER BANGLE IS A PRECIOUS CHARACTERISTIC OF THIS VASE.

**24 x h 15 cm**  
9.4 x h 5.9 inch  
5,7 kg / 12.6 lb

# GAE VASE

BANGLE COLLECTION



GAE VASE

DESCRIPTION

DIMENSIONS

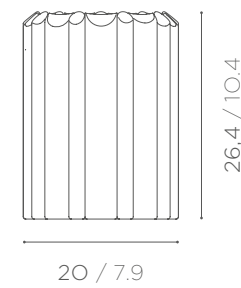

CYLINDRICAL VASE MADE OF 'STRAWS' IN AZUL MACAUBA AND NERO ASSOLUTO. THE BOTTOM OF THE VASE IS IN AZUL MACAUBA.

**20 x h 26,4 cm**  
7.9 x h 10.4 inch  
8 kg / 17.6 lb





# LEA VASE

BANGLE COLLECTION



LEA VASE

DESCRIPTION

DIMENSIONS

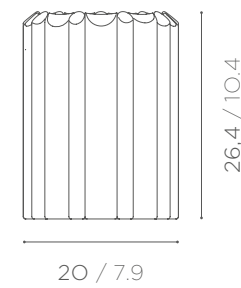

CYLINDRICAL VASE MADE OF 'STRAWS' IN GIALLO SIENA AND NERO ASSOLUTO. THE BOTTOM OF THE VASE IS IN GIALLO SIENA.

**20 x h 26,4 cm**  
7.9 x h 10.4 inch  
7,6 kg / 16.75 lb



CRISTINA CELESTINO

VASES

# FRIDA TRAY

BANGLE COLLECTION



FRIDA TRAY

#### DESCRIPTION

TRAY MADE OF EMERALD GREEN AND HONEY ONYX, COMPOSED BY THREE TRAYS WITH ENGRAVED EDGE.

#### DIMENSIONS

**30 x h 1.5 cm**  
11.8 x h 0.6 inch  
2,2 kg / 4.85 lb

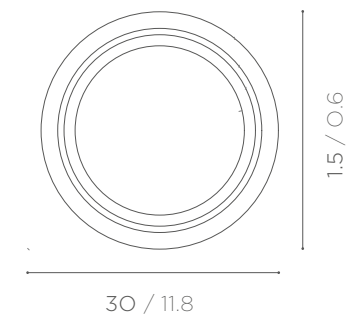



# COCO PRECIOUS BOX

BANGLE COLLECTION



COCO PRECIOUS BOX

DESCRIPTION

DIMENSIONS

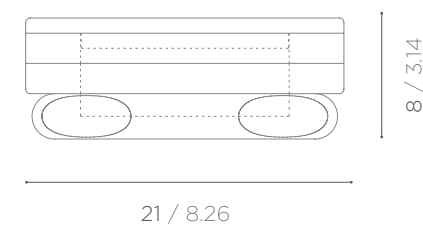

PRECIOUS BOX IN NERO MARQUINIA, PINK ONYX AND WHITE ONYX WITH COVER IN PINK ONYX.

**21 x h 8 cm**  
8.3 x h 3.1 inch  
3,8 kg / 8.4 lb



# GRACE PRECIOUS BOX

BANGLE COLLECTION



## GRACE PRECIOUS BOX

## DESCRIPTION

## DIMENSIONS

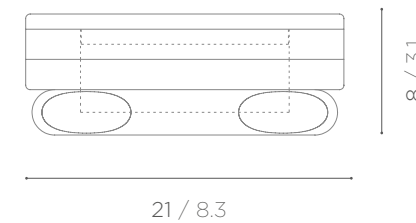

PRECIOUS JEWEL BOX IN EMERALD GREEN, HONEY ONYX AND BIANCO STATUARIO. COVER IN HONEY ONYX.

**21 x h 8 cm**  
8.3 x h 3.1 inch  
3,8 kg / 8.4 lb

# GWENNAEL NICOLAS

# WANDO VASES

## FRAGMENT COLLECTION



(L)

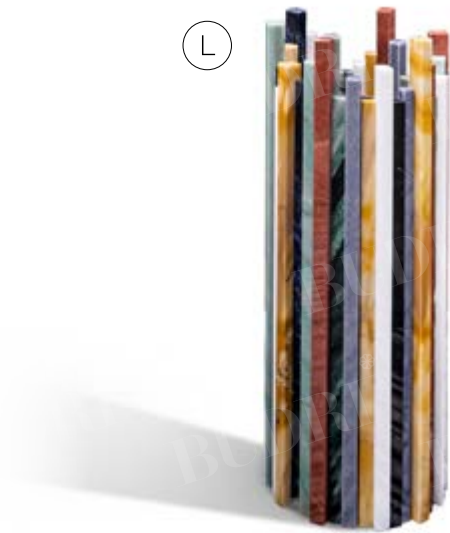

(S)



### WANDO VASE S

#### DESCRIPTION

#### DIMENSIONS

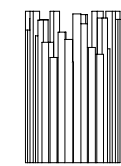

30 / 11.8

20 / 7.9

VASE MADE UP OF RODS OF DIFFERENT HEIGHTS AND THICKNESSES, IN PRECIOUS POLYCHROME MARBLES SUCH AS LAPONIA GREEN, GIALLO SIENA, RUPAS RED, LAPIS LAZULI, EMERALD GREEN, SIVEC WHITE, BLACK MARQUINA AND AZUL MACAUBAS.

ø 20 x h 30 cm  
ø 7.9 x h 11.8 inch  
8,5 kg / 18.7 lb

### WANDO VASE L

#### DESCRIPTION

#### DIMENSIONS

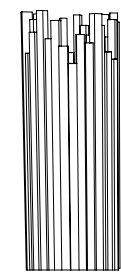

50 / 19.6

20 / 7.9

VASE MADE UP OF RODS OF DIFFERENT HEIGHTS AND THICKNESSES, IN PRECIOUS POLYCHROME MARBLES SUCH AS LAPONIA GREEN, GIALLO SIENA, RUPAS RED, LAPIS LAZULI, EMERALD GREEN, SIVEC WHITE, BLACK MARQUINA AND AZUL MACAUBAS.

ø 20 x h 50 cm  
ø 7.9 x h 19.6  
11,5 kg / 25.4 lb

# VASUM

MARMOR NATVM COLLECTION



VASUM

DESCRIPTION

DIMENSIONS

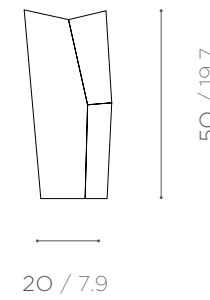

VASUM IS MADE FROM FIVE DIFFERENT POLYGONS, UNITED BY THE GRAIN OF PICTORIAL MARBLES.

**20 x h 50 cm**  
7,9 x h 19,7 inch  
6 kg / 13.2 lb

AVAILABLE IN PANDA WHITE (ON THE LEFT) AND IN NERO COPACABANA (ON THE RIGHT).







# PATRICIA URQUIOLA

# BIG PIERCE LIVING TABLE

AQUAREL COLLECTION



BIG PIERCE LIVING TABLE

DESCRIPTION

DIMENSIONS

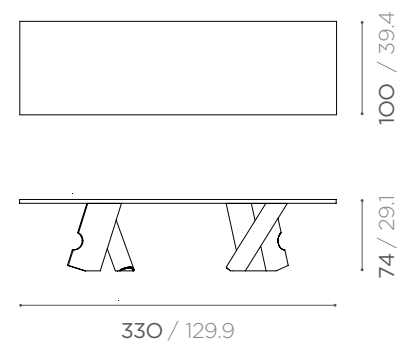

LIVING TABLE MADE OF TRAVERTINO CLASSICO ROMANO WITH NATURAL PORE AND SANDBLASTED FINISH, BIG PIERCE HAS A LARGE RECTANGULAR MONOLITHIC TABLE TOP.

**330 x 100 x h 74 cm**  
129.9 x 39.4 x h 29.1 inch  
375 kg / 826,73 lb

TABLE FEET IN TRAVERTINO CLASSICO ROMANO WITH NATURAL PORE AND SANDBLASTED FINISH AND WHITE IRANIAN ONYX.

# PIERCE LIVING TABLE

AQUAREL COLLECTION



PIERCE LIVING TABLE

DESCRIPTION

DIMENSIONS

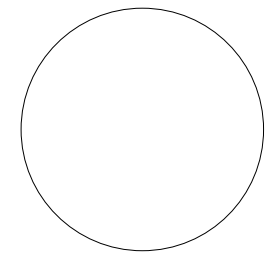

150 / 59

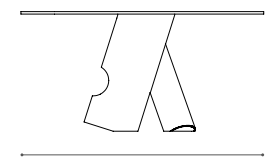

74 / 29.1

150 / 59

LIVING TABLE CHARACTERIZED BY A CIRCULAR EXTRA-CLEAR GLASS TOP THAT RESTS ON A MONOLITHIC TRAVERTINO ROMANO CLASSICO BASE AND ITS BEARING COLUMN IN AQUAREL MINT ONYX.

**ø 150 x h 74 cm**  
 ø 59 x h 29.1 inch  
 190 kg / 418.88 lb

PATRICIA URQUIOLA

LIVING TABLES

# MAREA LIVING TABLE

AGUA COLLECTION - AQUAREL EDITION



MAREA LIVING TABLE - AQUAREL EDITION

DESCRIPTION

DIMENSIONS

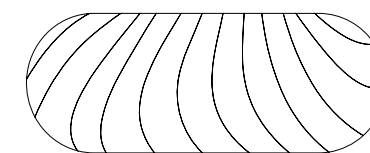

92 / 36.2



74 / 29.1

232 / 91.3

MAREA LIVING TABLE, FROM THE AGUA COLLECTION, IS A PRECIOUS LIVING TABLE WITH BISCUIT-SHAPED TABLE TOP, REALISED WITH ARTISTIC INLAYS OF PRECIOUS MARBLES IN GREEN SHADES.

MADE IN PINK ONYX, TRAVERTINO ROMANO CLASSICO, AFGHAN ONYX, IVORY ONYX, HONEY ONYX.

CURVED TABLE LEGS IN SOLID TRAVERTINO ROMANO CLASSICO.

**240 x 90 x h 72 cm**  
94.5 x 35.4 x h 28.3 inch  
**160 kg / 352.5 lb**

# ARCHITEXTURE LIVING TABLE O1

ARCHITEXTURE COLLECTION

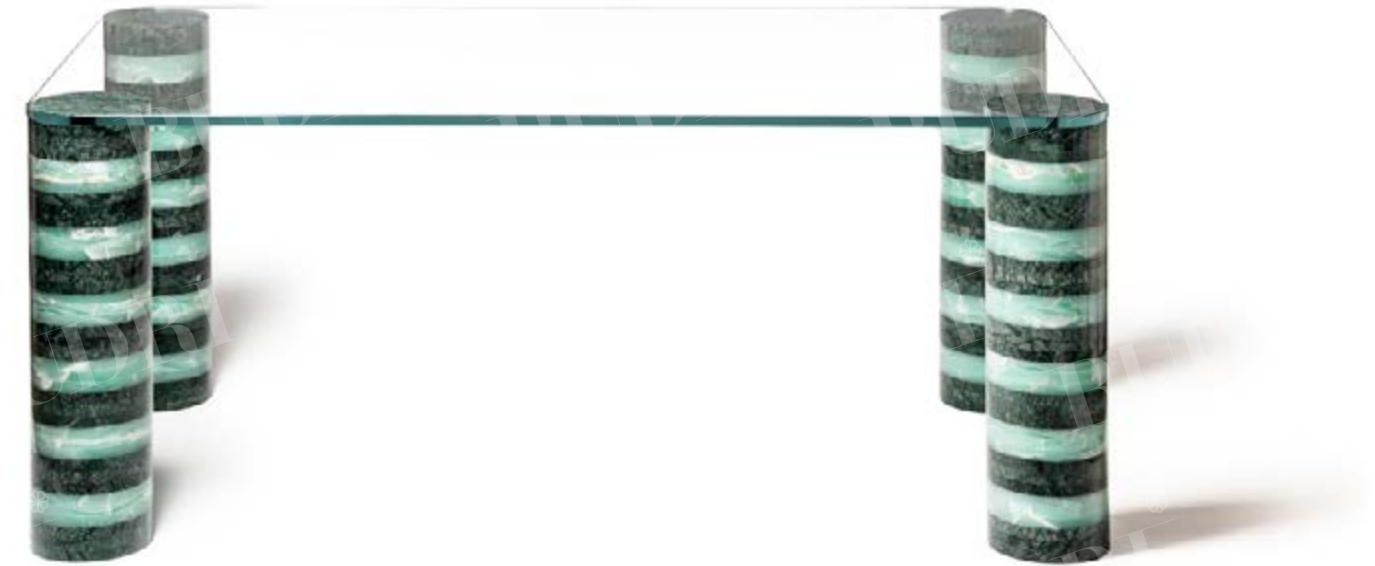

LIVING TABLE O1

DESCRIPTION

DIMENSIONS



LIVING TABLE WITH 4 LEGS,  
AVAILABLE IN:

**S 180 x 100 x h 74,5 cm**  
70.9 x 39.4 x h 29.3 inch  
200 kg / 441 lb

① VERDE GUATEMALA AND  
AQUAREL MINT ONYX.

**M 200 x 120 x h 74,5 cm**  
78.7 x 47.2 x h 29.3 inch  
250 kg / 551 lb

② NERO PORTORO AND  
TRAVERTINO CLASSICO ROMANO  
WITH OPEN PORE;

**L 240 x 130 x h 74,5 cm**  
94.5 x 47.2 x h 29.3 inch  
312 kg / 688 lb

③ AQUAREL MANDARIN ONYX AND  
TRAVERTINO CLASSICO ROMANO  
WITH OPEN PORE.

TABLE TOP IN EXTRA CLEAR  
TEMPERED GLASS.

MATERIAL COMBINATIONS

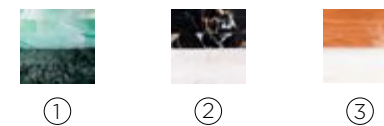

# ARCHITEXTURE LIVING TABLE O2

ARCHITEXTURE COLLECTION



LIVING TABLE O2

DESCRIPTION

DIMENSIONS

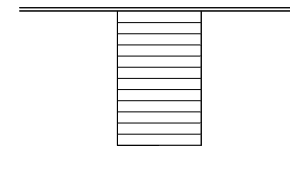

72,5 / 28.5

150 / 59

LIVING TABLE WITH CENTRAL COLUMN IN NERO PORTORO AND SANDBLASTED TRAVERTINO CLASSICO WITH OPEN PORE. TABLE TOP IN EXTRA CLEAR TEMPERED GLASS.

ø 150 x h 72,5 cm  
ø 59 x h 28.5 inch  
180 kg / 397 lb

# ARCHITEXTURE LIVING TABLE O3

ARCHITEXTURE COLLECTION



LIVING TABLE O3

DESCRIPTION

DIMENSIONS

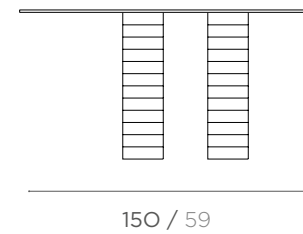

LIVING TABLE WITH 3 LEGS IN VERDE CIPOLLINO AND VERDE GUATEMALA.

Ø 150 x h 72,5 cm  
Ø 59 x h 28.5 inch  
180 kg / 397 lb

TABLE TOP IN EXTRA CLEAR TEMPERED GLASS.

# MAREA LIVING TABLE

AGUA COLLECTION



MAREA LIVING TABLE

DESCRIPTION

DIMENSIONS

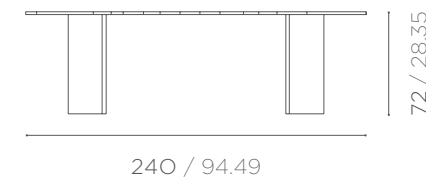

PRECIOUS LIVING TABLE WITH BISCUIT-SHAPED TABLE TOP, REALISED WITH ARTISTIC INLAYS OF PRECIOUS MARBLES IN GREEN SHADES. AMONG THE STONES: VERDE ACQUAMARINA, VERDE LAPONIA, VERDE ALPI. CURVED TABLE LEGS IN SOLID VERDE LAPONIA MARBLE.

**240 x 90 x h 72 cm**  
94.5 x 35.4 x h 28.3 inch  
**160 kg / 352.5 lb**



# ORILLA LIVING TABLE

AGUA COLLECTION

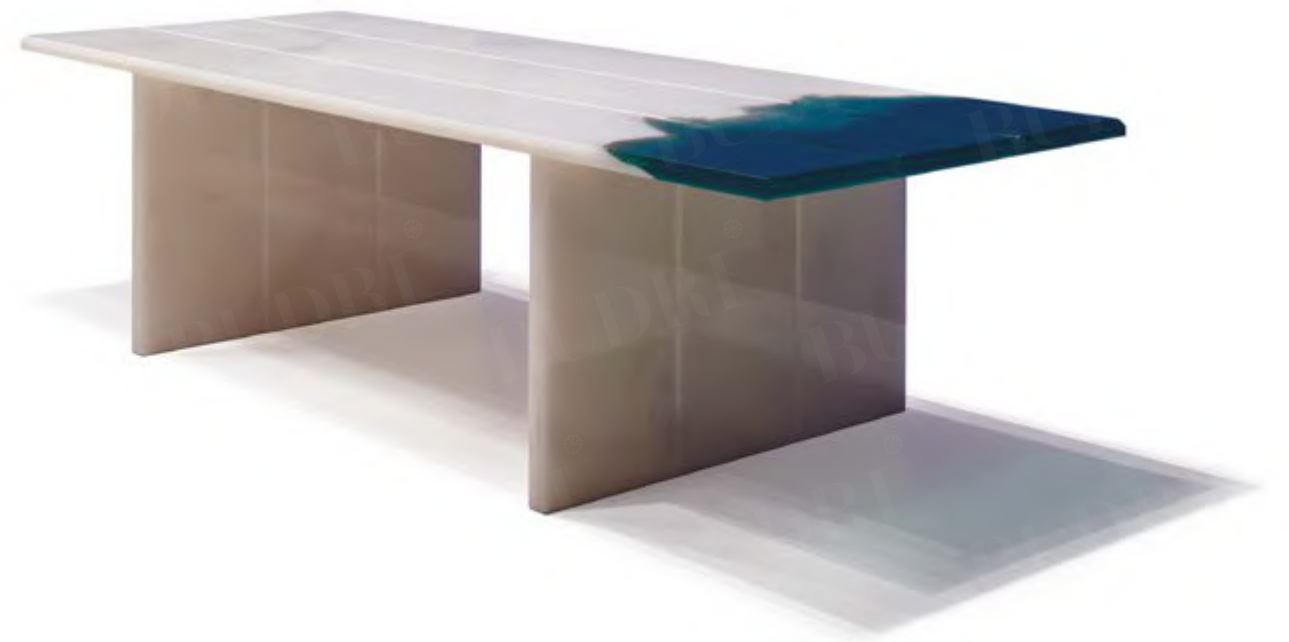

ORILLA LIVING TABLE

DESCRIPTION

DIMENSIONS

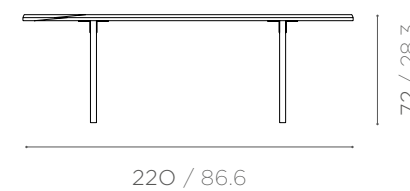

PRECIOUS LIMITED EDITION LIVING TABLE, IN WHITE IRANIAN ONYX, WITH RECTANGULAR TABLE TOP (4 CM THICK), FORMED GRAPHICALLY BY THREE PLANKS AND EDGES WITH BLACK MESH SCAR AND EMERALD GREEN RESIN.

**220 x 90 x h 72 cm**  
86.6 x 35.4 x h 28.3 inch  
291 kg / 641.5 lb

THE LEGS OF THE TABLE IN WHITE IRANIAN ONYX OF THE SAME THICKNESS ARE FORMED GRAPHICALLY BY THREE PLANKS TO MATCH THE TABLE TOP DESIGN.

# CONE TABLE - WALLPAPER

PAPIRO COLLECTION



CÓNE TABLE - WALLPAPER

DESCRIPTION

PAPIRO LIVING TABLE WITH "WALLPAPER" EFFECT. INLAID AND CURVED TABLE TOP IN STATUARIO ALTISSIMO, STATUARIETTO, GRIGIO BARDIGLIO, ROSA DEL PORTOGALLO SALMONE MARBLES.

TABLE LEGS IN CHILEAN WOOD.

DIMENSIONS

- WALL INLAY:** 170 x 90 cm / 66.9 x 35.4 cm
- INLAID CURVE:** 40 x 90 cm / 15.7 x 35.4 cm
- TABLE TOP:** 226 x 90 cm / 89 x 35.4 cm
- THICKNESS:** 1 cm / 0.4 inch
- TOTAL WEIGHT:** 118 kg / 260 lb

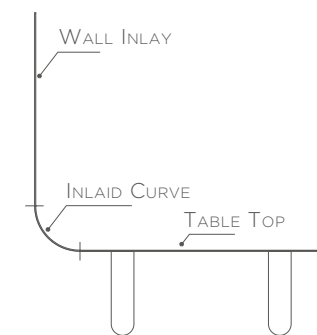

# CONE TABLE BLUE

PAPIRO COLLECTION



CÔNE TABLE BLUE

DESCRIPTION

DIMENSIONS

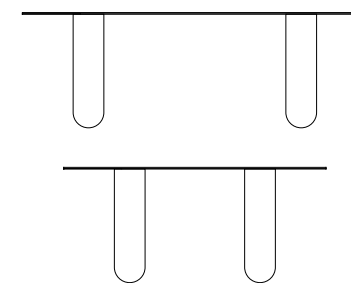

CÔNE TABLE BLUE

LIVING TABLE WITH INLAID TOP IN AQUAMARINE GREEN, AZUL BOQUIRA, BIANCO LASA AND CALACATTA MARBLES. TABLE LEGS IN CHILEAN WOOD.

\*ALSO AVAILABLE WITH MARBLES OF THE STANDARD "CÔNE" PATTERN.  
\*\*AVAILABLE IN TWO SIZES.

- a) **226 x 90 x h 72 cm**  
89 x 35.4 x h 28.3 inch  
THICKNESS 1 cm / 0.4 inch  
71 kg / 156.5 lb
- b) **170 x 90 x h 72 cm**  
66.9 x 35.4 x h 28.3  
THICKNESS 1 cm / 0.4 inch  
58 kg / 127.8 lb

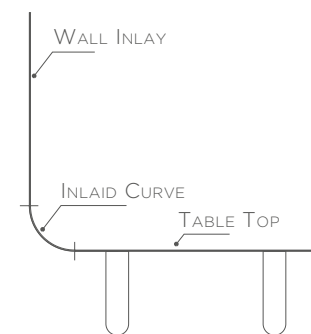

CÔNE TABLE BLUE - "WALLPAPER" EFFECT

LIVING TABLE WITH INLAID, CURVED TABLE TOP MADE IN AQUAMARINE GREEN, AZUL BOQUIRA, BIANCO LASA AND CALACATTA MARBLES. TABLE LEGS IN CHILEAN WOOD.

\*ALSO AVAILABLE WITH MARBLES OF THE STANDARD "CÔNE" PATTERN.

- WALL INLAY:** 170 x 90 cm / 66.9 x 35.4 cm
- INLAID CURVE:** 40 x 90 cm / 15.7 x 35.4 cm
- TABLE TOP:** 226 x 90 cm / 89 x 35.4 cm
- THICKNESS:** 1 cm / 0.4 inch
- TOTAL WEIGHT:** 118 kg / 260 lb

# AMELIE TABLE

PAPIRO COLLECTION



AMELIE TABLE

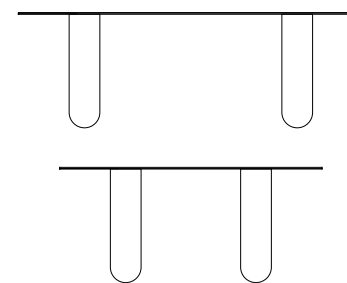

DESCRIPTION

**AMELIE TABLE**

LIVING TABLE WITH INLAID TOP IN ROSA DEL PORTOGALLO SALMONE, ROSA DEL PORTOGALLO ESTREMOZ, GREEN AQUAREL ONYX. TABLE LEGS IN CHILEAN WOOD.

\*AVAILABLE IN TWO SIZES.

DIMENSIONS

- a) **226 x 90 x h 72 cm**  
89 x 35.4 x h 28.3 inch  
THICKNESS **1 cm** / 0.4 inch  
**71 kg** / 156.5 lb
- b) **170 x 90 x h 72 cm**  
66.9 x 35.4 x h 28.3  
THICKNESS **1 cm** / 0.4 inch  
**58 kg** / 127.8 lb

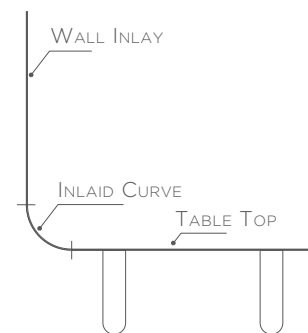

**AMELIE TABLE - "WALLPAPER" EFFECT**

LIVING TABLE WITH INLAID, CURVED TOP MADE IN ROSA DEL PORTOGALLO SALMONE, ROSA DEL PORTOGALLO ESTREMOZ MARBLES AND GREEN AQUAREL ONYX. TABLE LEGS IN CHILEAN WOOD.

- WALL INLAY:** 170 x 90 cm / 66.9 x 35.4 cm
- INLAID CURVE:** 40 x 90 cm / 15.7 x 35.4 cm
- TABLE TOP:** 226 x 90 cm / 89 x 35.4 cm
- THICKNESS:** 1 cm / 0.4 inch
- TOTAL WEIGHT:** 118 kg / 260 lb

# BISCUIT TABLE

PAPIRO COLLECTION



BISCUIT TABLE

DESCRIPTION

DIMENSIONS

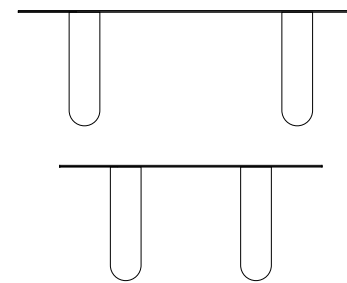

**BISCUIT TABLE**

LIVING TABLE WITH INLAID TOP IN AZUL MACAUBAS, MACEDONIAN ONYX, ROSA PORTOGALLO ESTREMOZ, ROSA PORTOGALLO SALMONE. TABLE LEGS IN CHILEAN WOOD.

\*AVAILABLE IN TWO SIZES.

- a) **226 x 90 x h 72 cm**  
89 x 35.4 x h 28.3 inch  
THICKNESS **1 cm** / 0.4 inch  
**71 kg** / 156.5 lb
- b) **170 x 90 x h 72 cm**  
66.9 x 35.4 x h 28.3  
THICKNESS **1 cm** / 0.4 inch  
**58 kg** / 127.8 lb

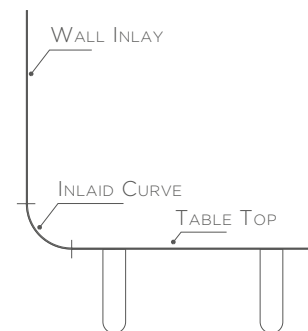

**BISCUIT TABLE "WALLPAPER" EFFECT**

LIVING TABLE WITH INLAID, CURVED TOP MADE IN AZUL MACAUBAS, MACEDONIAN ONYX, ROSA PORTOGALLO ESTREMOZ, ROSA PORTOGALLO SALMONE. TABLE LEGS IN CHILEAN WOOD.

- WALL INLAY:** 170 x 90 cm / 66.9 x 35.4 cm
- INLAID CURVE:** 40 x 90 cm / 15.7 x 35.4 cm
- TABLE TOP:** 226 x 90 cm / 89 x 35.4 cm
- THICKNESS:** 1 cm / 0.4 inch
- TOTAL WEIGHT:** 118 kg / 260 lb

# BON BON TABLE

PAPIRO COLLECTION



BON BON TABLE

DESCRIPTION

DIMENSIONS

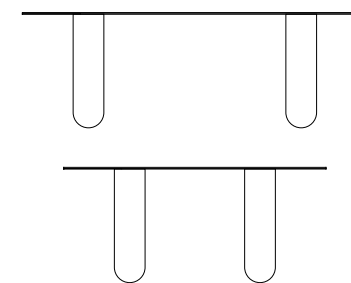

BON BON TABLE

LIVING TABLE WITH INLAID TOP IN BIANCO SIVEC, MANDARIN ONYX, PINK ONYX, ROSA DEL PORTOGALLO ESTREMOZ, HONEY ONYX.  
TABLE LEGS IN CHILEAN WOOD

\*AVAILABLE IN TWO SIZES.

- a) **226 x 90 x h 72 cm**  
89 x 35.4 x h 28.3 inch  
THICKNESS **1 cm** / 0.4 inch  
71 kg / 156.5 lb
- b) **170 x 90 x h 72 cm**  
66.9 x 35.4 x h 28.3  
THICKNESS **1 cm** / 0.4 inch  
58 kg / 127.8 lb

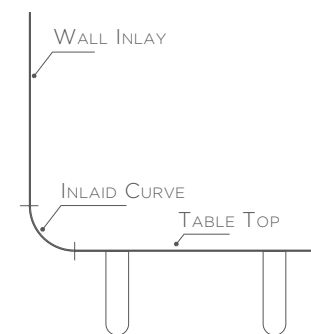

BON BON TABLE - "WALLPAPER" EFFECT

LIVING TABLE WITH INLAID, CURVED TOP MADE IN BIANCO SIVEC, MANDARIN ONYX, PINK ONYX, ROSA DEL PORTOGALLO ESTREMOZ, HONEY ONYX.  
TABLE LEGS IN CHILEAN WOOD.

- WALL INLAY:** 170 x 90 cm / 66.9 x 35.4 cm
- INLAID CURVE:** 40 x 90 cm / 15.7 x 35.4 cm
- TABLE TOP:** 226 x 90 cm / 89 x 35.4 cm
- THICKNESS:** 1 cm / 0.4 inch
- TOTAL WEIGHT:** 118 kg / 260 lb

# BALLON TABLE

PAPIRO COLLECTION



CALACATTA, BIANCO LASA  
COVELANO, ROSA DEL  
PORTOGALLO SALMONE,  
IVORY ONYX, BLUE AQUA-  
REL ONYX

BALLON TABLE

DESCRIPTION

DIMENSIONS

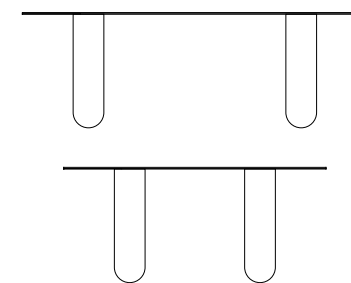

BALLON TABLE

LIVING TABLE WITH INLAID TOP IN CALACATTA, BIANCO LASA COVELANO, ROSA DEL PORTOGALLO SALMONE, IVORY ONYX, BLUE AQUAREL ONYX. TABLE LEGS IN CHILEAN WOOD

- a) **226 x 90 x h 72 cm**  
89 x 35.4 x h 28.3 inch  
THICKNESS **1 cm** / 0.4 inch  
**71 kg** / 156.5 lb
- b) **170 x 90 x h 72 cm**  
66.9 x 35.4 x h 28.3  
THICKNESS **1 cm** / 0.4 inch  
**58 kg** / 127.8 lb

\*AVAILABLE IN TWO SIZES.

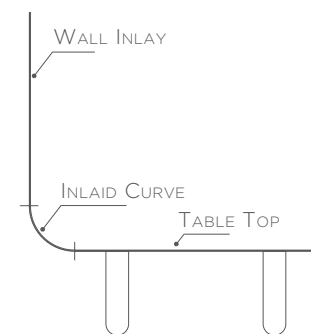

BALLON TABLE - "WALLPAPER" EFFECT

LIVING TABLE WITH INLAID, CURVED TOP MADE IN CALACATTA, BIANCO LASA COVELANO, ROSA DEL PORTOGALLO SALMONE, IVORY ONYX, BLUE AQUAREL ONYX. TABLE LEGS IN CHILEAN WOOD.

- WALL INLAY:** 170 x 90 cm / 66.9 x 35.4 cm
- INLAID CURVE:** 40 x 90 cm / 15.7 x 35.4 cm
- TABLE TOP:** 226 x 90 cm / 89 x 35.4 cm
- THICKNESS:** 1 cm / 0.4 inch
- TOTAL WEIGHT:** 118 kg / 260 lb

# EARTHQUAKE TABLE

EARTHQUAKE 5.9 COLLECTION



## EARTHQUAKE TABLE

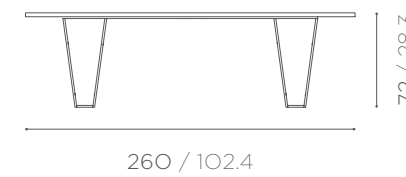

## DESCRIPTION

LIVING TABLE WITH TOP MADE IN INLAID PRECIOUS MARBLES, ONYXES AND IVORY WHITE RESIN. LIGHT-GREEN METAL FEET.

## DIMENSIONS

**260 x 130 x h 72 cm**  
102.5 x 51.2 x h 28.3 inch  
189 kg / 417 lb



# CANYON TABLE YELLOW

NAT|F|USE COLLECTION



CANYON TABLE YELLOW

DESCRIPTION

DIMENSIONS

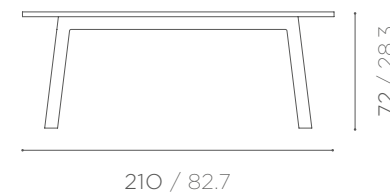

PRECIOUS SLAB OF WHITE ONYX, RE-COMPOSED WITH THE FLUO YELLOW RESIN. BLACK IRON FEET.

**210 x 112 x h 72 cm**  
82.7 x 76.7 x h 28.3 inch  
130 kg / 286.6 lb

# CANYON TABLE PINK

NAT|F|USE COLLECTION



CANYON TABLE PINK

## DESCRIPTION

LIVING TABLE WITH TOP MADE FROM A PRECIOUS SLAB OF PINK ONYX RECOMPOSED WITH CREAM AND LIGHT ROSE COLOURED RESIN. TABLE FEET GOLDEN METAL.

## DIMENSIONS

**210 x 112 x h 72 cm**  
82.7 x 76.7 x h 28.3 inch  
130 kg / 286.6 lb

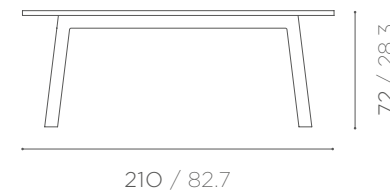

# MARBLELACE BISCUIT TABLE

MARBLELACE COLLECTION

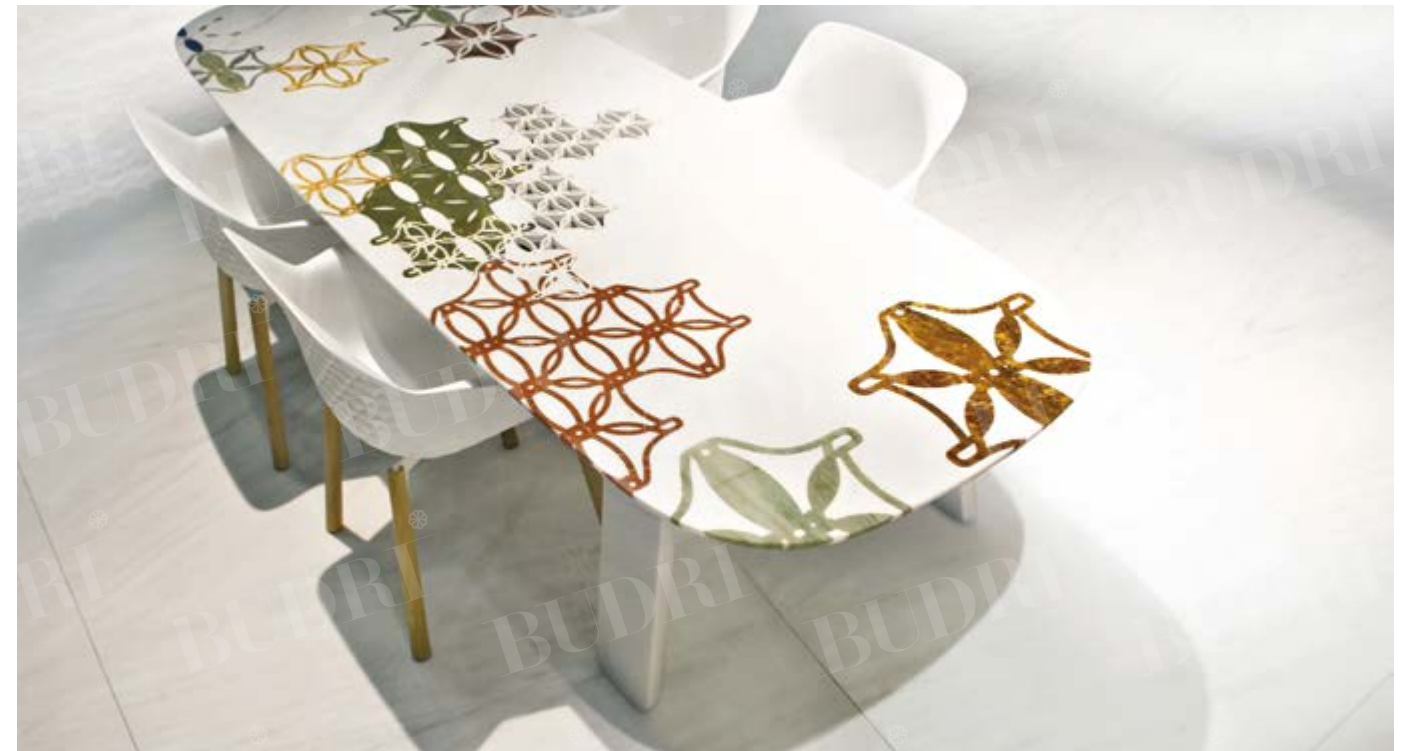

MARBLELACE BISCUIT TABLE

DESCRIPTION

DIMENSIONS



270 / 106.3

73.5 / 28.9

LIVING TABLE IN BIANCO LASA MARBLE  
INLAID WITH PRECIOUS MARBLES AND  
TRANSLUCENT, OPENWORKED LACES.

**270 x 95 x h 73,5 cm**  
106.3 x 37.4 x h 28.9 inch  
310 kg / 683 lb

# GWENNAEL NICOLAS

# BAKODO LIVING TABLE

FRAGMENT COLLECTION



BAKODO LIVING TABLE

### DESCRIPTION

### DIMENSIONS



260 / 102.3

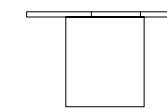

120 / 47.2

LIVING TABLE WITH STRIPED PATTERN IN MARBLE IN SHADES OF WHITE AND GRAY, WITH FEET IN METAL WITH A MIRROR EFFECT. MADE OF STRIATO OLIMPICO, BIANCO SIVEC, BIANCO NAMIBIA AND BIANCO COVELANO MARBLES.

**260 x 120 x h 72 cm**  
 102.3 x 47.2 x h 28.3 inch  
 143 kg / 315.2 lb

# INITIUM LIVING TABLE

MARMOR NATVM COLLECTION

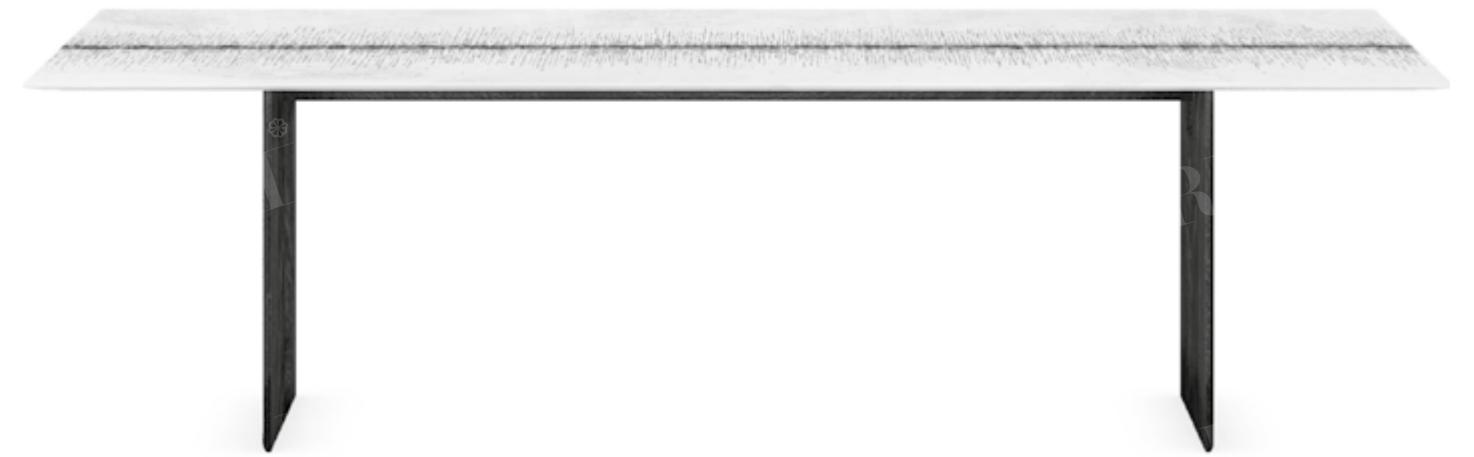

INITIUM LIVING TABLE

DESCRIPTION

DIMENSIONS



73.5 / 28.9

260 / 102.3

LIVING TABLE IN CALACATTA FOX MARBLE WITH INLAYS IN SUPER WHITE, PORTORO SILVER AND FIOR DI BOSCO.

**260 x 110 x h 73,5 cm**  
102.3 x 43.3 x h 28.9 inch  
164 kg / 361.5 lb

# MAARTEN DE CEULAER

# RECTANGULAR LIVING TABLE

PANTHEON COLLECTION



RECTANGULAR LIVING TABLE

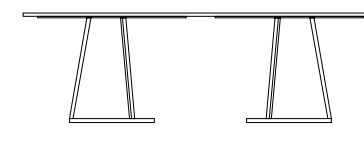

240 / 102.3

75 / 29.5

DESCRIPTION

RECTANGULAR LIVING TABLE,  
BACKGROUND IN NERO BELGIO MARBLE,  
CIRCLES IN OPERA D'ARTE MARBLE.  
TABLE FEET IN BRUSHED METAL, MATTE  
BLACK.

DIMENSIONS

**240 x 120 x h 75 cm**  
**ø foot base 57,5 cm**

102.3 x 43.3 x h 28.9 inch  
ø foot base 22,4 inch

263 kg / 579 lb



# OVAL LIVING TABLE

PANTHEON COLLECTION



OVAL LIVING TABLE

DESCRIPTION

DIMENSIONS

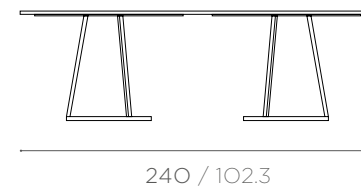

OVAL SHAPED LIVING TABLE, BACKGROUND IN IRANIAN WHITE ONYX, CIRCLES IN HONEY ONYX AND AFGHAN ONYX. TABLE FEET IN SATIN AND BRUSHED GOLDEN METAL.

**240 x 120 x h 75 cm**  
**ø foot base 57,5 cm**

102.3 x 43.3 x h 28.9 inch  
 ø foot base 22,4 inch

250 kg / 551 lb

# ROUND LIVING TABLE

PANTHEON COLLECTION



ROUND LIVING TABLE

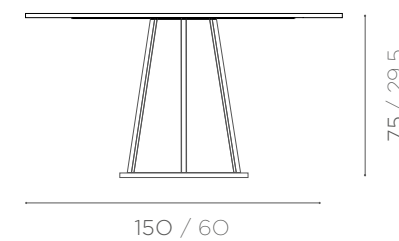

DESCRIPTION

ROUND LIVING TABLE IN LOUIS BLUE MARBLE. TABLE FEET IN BRUSHED METAL, MATTE BLACK.

DIMENSIONS

ø 150 x h 75 cm  
ø foot base 64 cm

ø 60 inch x h 29.5 inch  
ø foot base 25 inch

150 kg / 330.7 lb

# SQUARE LIVING TABLE

PANTHEON COLLECTION



SQUARE LIVING TABLE

DESCRIPTION

DIMENSIONS

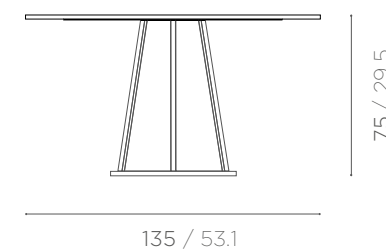

SQUARE LIVING TABLE,  
BACKGROUND IN CALACATTA GOLD, INNER  
CIRCLE IN MULTICOLOR ONYX.

TABLE FEET IN MATTE BLACK METAL.

**135 x 135 x h 75 cm**  
**ø foot base 64 cm**

53.1 x 53.1 x h 29.5 inch  
ø foot base 25 inch

193 kg / 425.5 lb

# COFFEE & SIDE TABLES

# PATRICIA URQUIOLA

# GELATOSO COFFEE TABLE

AQUAREL COLLECTION



### GELATOSO COFFEE TABLE

### DESCRIPTION

### DIMENSIONS

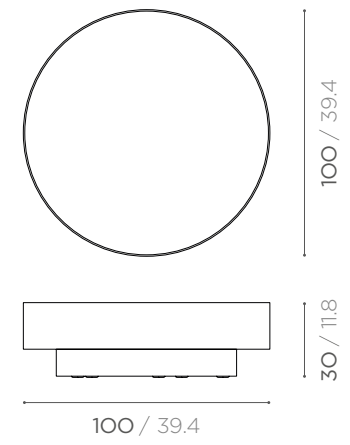

CIRCULAR COFFEE TABLE MADE OF WHITE IRANIAN ONYX, HAND-WATERCOLORED WITH GRADIENTS IN SORBET TONES: PEACH, APRICOT, LEMON AND CORAL.

TABLE BASE IN LIME GREEN METAL.

**ø 100 x h 30 cm**  
 ø 39.4 x h 11.8 inch  
 65 Kg / 143.3 lb

PATRICIA URQUIOLA

COFFEE & SIDE TABLES

# ORIGAMI "AMETHYST" COFFEE TABLE

EARTHQUAKE 5.9 COLLECTION - AQUAREL EDITION



ORIGAMI AMETHYST - COFFEE TABLE

DESCRIPTION

ORIGAMI COFFEE TABLES, FROM THE EARTHQUAKE 5.9 COLLECTION - SPECIAL AQUAREL EDITION.

BODY IN WHITE IRANIAN ONYX WITH HAND-WATERCOLORED "AMETHYST" PATTERN.

DIMENSIONS

**128 x 76,4 x h 30 cm**  
50.4 x 30.1 x h 11.8 inch  
81 kg / 178.6 lb

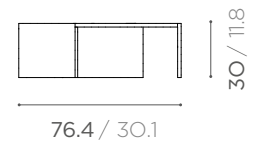
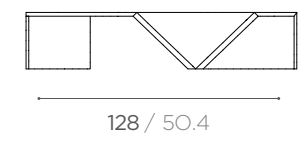
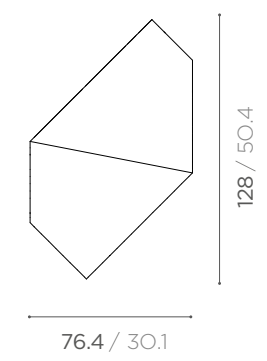

PATRICIA URQUIOLA

COFFEE & SIDE TABLES

# ORIGAMI "MIMOSA" COFFEE TABLE

EARTHQUAKE 5.9 COLLECTION - AQUAREL EDITION



ORIGAMI MIMOSA - COFFEE TABLE

### DESCRIPTION

ORIGAMI COFFEE TABLES, FROM THE EARTHQUAKE 5.9 COLLECTION - SPECIAL AQUAREL EDITION.

BODY IN WHITE IRANIAN ONYX WITH HAND-WATERCOLORED "MIMOSA" PATTERN.

### DIMENSIONS

**128 x 76,4 x h 30 cm**  
50.4 x 30.1 x h 11.8 inch  
81 kg / 178.6 lb

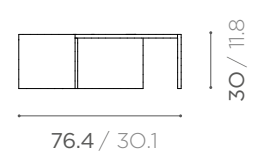
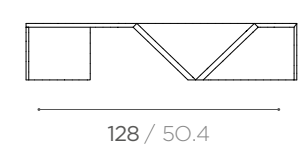
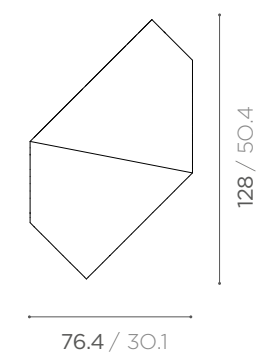



PATRICIA URQUIOLA

COFFEE & SIDE TABLES

# ORIGAMI "QUEEN ELIZABETH II" COFFEE TABLE

EARTHQUAKE 5.9 COLLECTION - AQUAREL EDITION



## ORIGAMI QUEEN ELIZABETH II

## DESCRIPTION

## DIMENSIONS

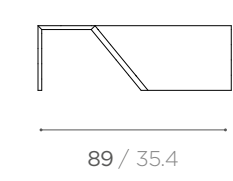
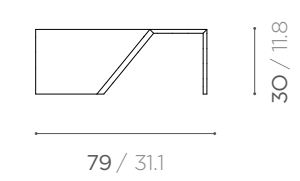
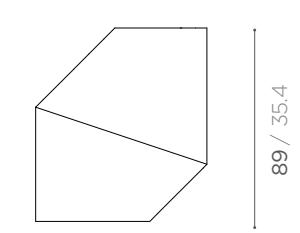

ORIGAMI COFFEE TABLES, FROM THE EARTHQUAKE 5.9 COLLECTION - SPECIAL AQUAREL EDITION.

BODY IN WHITE IRANIAN ONYX WITH HAND-WATERCOLORED "QUEEN ELIZABETH II" PATTERN.

**89 x 79 x h 30 cm**  
35 x 31.1 x h 11.8 inch  
65 kg / 143.3 lb

PATRICIA URQUIOLA

COFFEE & SIDE TABLES

# ORIGAMI "INCISO PINK" COFFEE TABLE

EARTHQUAKE 5.9 COLLECTION - AQUAREL EDITION



ORIGAMI AMETHYST - COFFEE TABLE

### DESCRIPTION

### DIMENSIONS

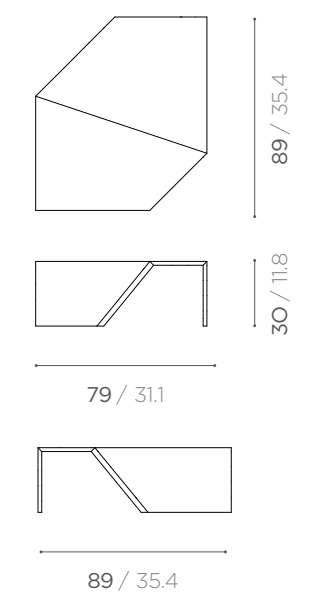

ORIGAMI COFFEE TABLES, FROM THE EARTHQUAKE 5.9 COLLECTION - SPECIAL AQUAREL EDITION.

BODY IN WHITE IRANIAN ONYX WITH HAND-WATERCOLORED "INCISO" PATTERN.

**89 x 79 x h 30 cm**  
35 x 31.1 x h 11.8 inch  
65 kg / 143.3 lb

# ARCHITEXTURE COFFEE TABLE O4

ARCHITEXTURE COLLECTION



COFFEE TABLE O4

DESCRIPTION

DIMENSIONS

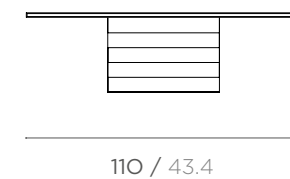

COFFEE TABLE WITH ONE CENTRAL STRIPED COLUMN. AVAILABLE IN:

**ø 110 x h 28,5 cm**  
 ø 43.3 x h 11.2 inch  
 75 kg / 165 lb

- ① PINK ONYX AND SANDBLASTED TRAVERTINO CLASSICO WITH OPEN PORE;
- ② NERO PORTORO AND SANDBLASTED TRAVERTINO CLASSICO WITH OPEN PORE.

MATERIAL COMBINATIONS

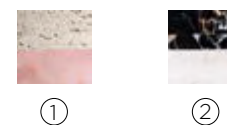

TABLE TOP IN EXTRA CLEAR TEMPERED GLASS.



# ARCHITEXTURE COFFEE TABLE O5

ARCHITEXTURE COLLECTION



ARCHITEXTURE COFFEE TABLE O5

DESCRIPTION

DIMENSIONS

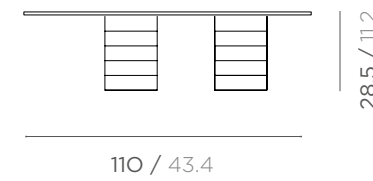

COFFEE TABLE WITH 3 STRIPED LEGS.  
AVAILABLE IN:

**ø 110 x h 28,5 cm**  
ø 43.3 x h 11.2 inch  
75 kg / 165 lb

- ① CARAMEL ONYX AND AQUAREL PINK ONYX;
- ② NERO PORTORO AND TRAVERTINO CLASSICO ROMANO WITH OPEN PORE;
- ③ VERDE GUATEMALA AND AQUAREL MINT ONYX.

MATERIAL COMBINATIONS

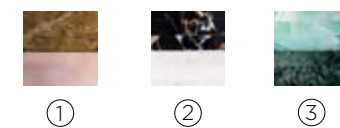
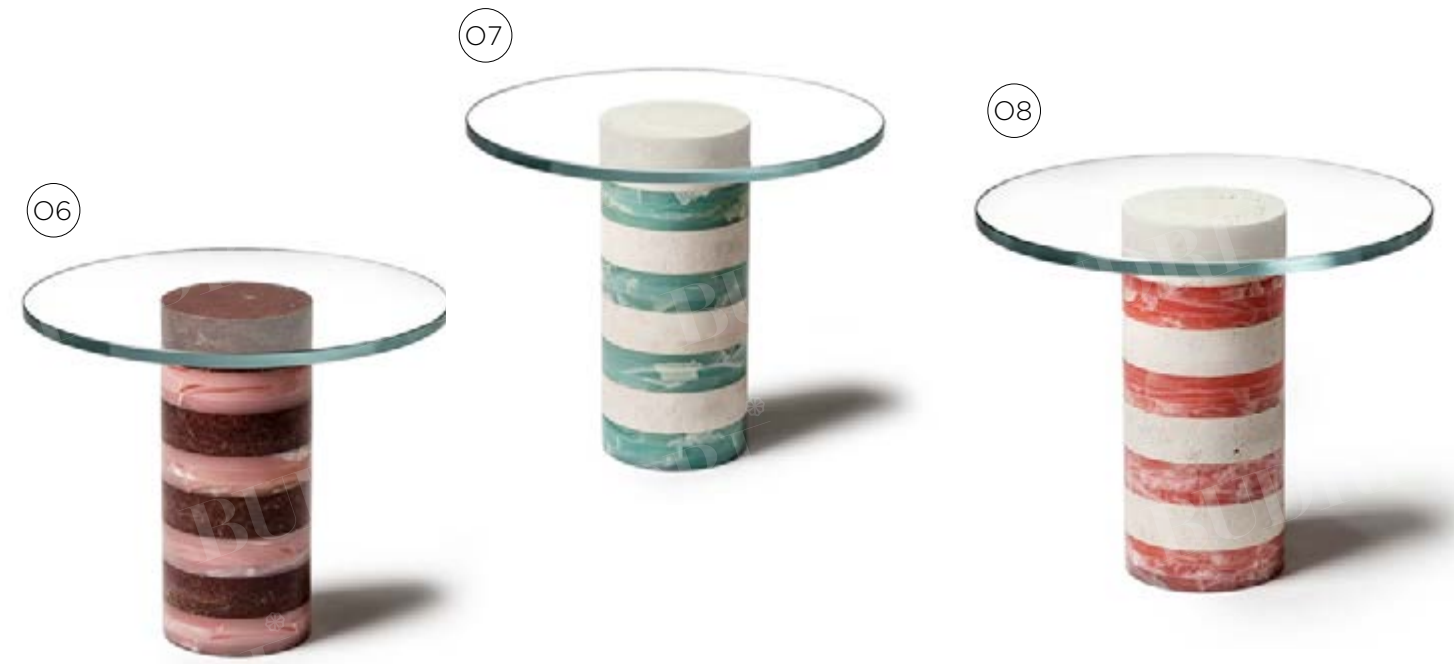

TABLE TOP IN EXTRA CLEAR  
TEMPERED GLASS.

# ARCHITEXTURE SIDE TABLES

ARCHITEXTURE COLLECTION



ARCHITEXTURE SIDE TABLE

DESCRIPTION

DIMENSIONS

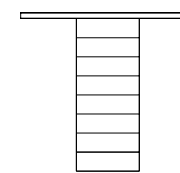

46,5 / 18,3

55 / 21,6

SIDE TABLE WITH CENTRAL COLUMN.  
AVAILABLE IN:

- 06 AQUAREL PINK ONYX AND ROSSO BAROCCO MARBLE;
- 07 AQUAREL MINT ONYX AND SANDBLASTED TRAVERTINO CLASSICO WITH OPEN PORE;
- 08 AQUAREL CORAL ONYX AND SANDBLASTED TRAVERTINO CLASSICO WITH OPEN PORE.

ø 55 x h 46,5 cm  
ø 21,6 x h 18,3 inch  
35 kg / 77 lb

MATERIAL COMBINATIONS



06

07

08

TABLE TOP IN EXTRA CLEAR TEMPERED GLASS.

# MAREA COFFEE TABLES

AGUA COLLECTION



MAREA COFFEE TABLES

DESCRIPTION

DIMENSIONS

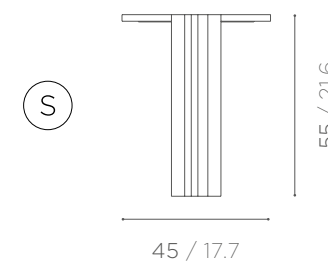

MAREA COFFEE TABLE S

BUTTON-SHAPED TOP REALIZED WITH INLAYS OF MARBLES IN PINK SHADES AND VERDE LIBERTY. AMONG THE MATERIALS USED: PINK QUARTZITE, SEQUOIA REDWOOD AND VERDE CIPOLLINO. THE LEG OF THE COFFEE TABLE IN SOLID MARBLE CONTINUES THE GRAPHIC PATTERN OF THE TOP.

**45 x 43,7 x h 55 cm**  
17.7 x 17.2 x h 21.6 inch  
30 kg / 66.1 lb

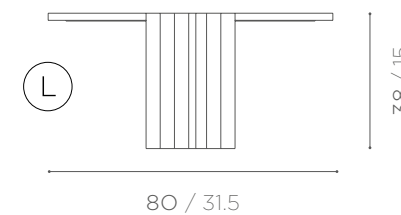

MAREA COFFEE TABLE L

BUTTON-SHAPED TOP REALIZED WITH INLAYS OF MARBLES IN PINK SHADES AND VERDE LIBERTY. AMONG THE MATERIALS USED: PINK QUARTZITE, SEQUOIA REDWOOD AND VERDE CIPOLLINO. THE LEG OF THE COFFEE TABLE IN SOLID MARBLE CONTINUES THE GRAPHIC PATTERN OF THE TOP.

**80 x 78 x h 38 cm**  
31.5 x 30.7 x h 14.9 inch  
53,8 kg / 118.6 lb

# PAPIRO COFFEE TABLES

PAPIRO COLLECTION



PAPIRO COFFEE TABLES

DESCRIPTION

DIMENSIONS

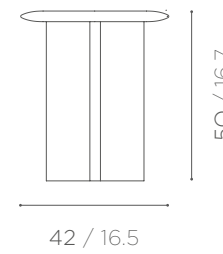

**AZUL COFFEE TABLE**

THE PAPIRO COFFEE TABLE IS MADE FROM AZUL MACAUBA, AN EXQUISITE QUARTZITE FROM THE MACAUBA QUARRY IN BRAZIL.

**ø 42 x h 50 cm**  
ø 16.5 x h 16.7 inch  
27,6 kg / 60.8 lb

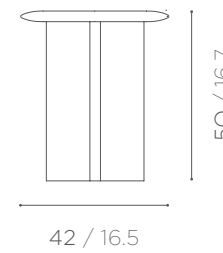

**PALISSANDRO COFFEE TABLE**

PAPIRO COFFEE TABLE MADE IN PALISSANDRO BLUETTE.

**ø 42 x h 50 cm**  
ø 16.5 x h 16.7 inch  
27,6 kg / 60.8 lb

# RABBIT COFFEE TABLES

RABBIT COLLECTION



RABBIT COFFEE TABLES

DESCRIPTION

DIMENSIONS

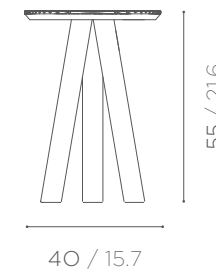

RABBIT COFFEE TABLE O1 - AZUL

COFFEE TABLE IN DEEP AZUL MACAUBAS WITH RIDGED TEXTURE TOP AND TUBULAR LEGS.

ø 40 x h 55 cm  
ø 15.7 x h 21.6 inch  
20,4 kg / 45 lb

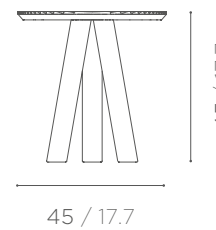

RABBIT COFFEE TABLE O2 - ROSA

COFFEE TABLE IN ROSA DEL PORTOGALLO WITH RIDGED TEXTURE TOP AND TUBULAR LEGS.

ø 45 x h 45 cm  
ø 17.7 x h 17.7 inch  
16,7 kg / 36.8 lb



# RABBIT COFFEE TABLES

RABBIT COLLECTION



RABBIT COFFEE TABLES

DESCRIPTION

DIMENSIONS

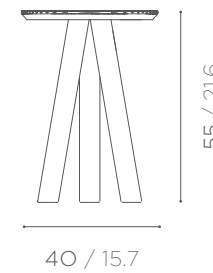

RABBIT COFFEE TABLE O1

COFFEE TABLE IN BIANCO STATUARIO WITH RIDGED TEXTURE TOP AND TUBULAR LEGS.

ø 40 x h 55 cm  
ø 15.7 x h 21.6 inch  
20,4 kg / 45 lb

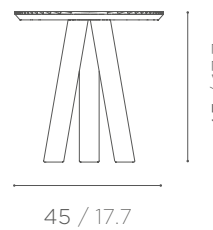

RABBIT COFFEE TABLE O2

COFFEE TABLE IN BIANCO STATUARIO WITH RIDGED TEXTURE TOP AND TUBULAR LEGS.

ø 45 x h 45 cm  
ø 17.7 x h 17.7 inch  
16,7 kg / 36.8 lb

# ORIGAMI RAINBOW S COFFEE TABLE

EARTHQUAKE 5.9 COLLECTION - SPECIAL EDITION

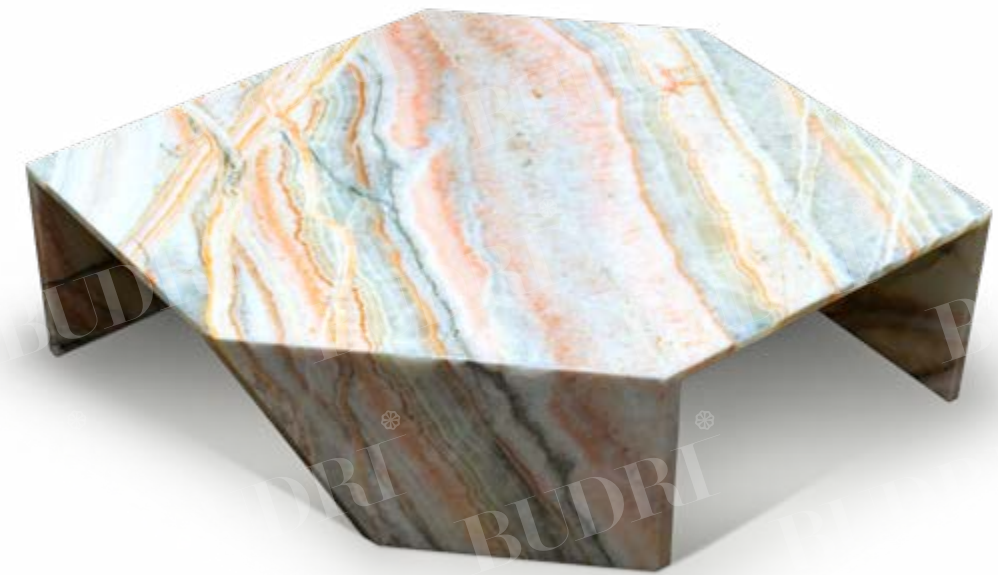

ORIGAMI RAINBOW S - COFFEE TABLE

### DESCRIPTION

ORIGAMI COFFEE TABLE,  
FROM THE EARTHQUAKE 5.9  
COLLECTION - SPECIAL RAINBOW ONYX  
EDITION.

BODY MADE ENTIRELY FROM A SINGLE,  
UNIQUE SLAB OF RAINBOW ONYX.

SIZE S.

### DIMENSIONS

**89 x 79 x h 30 cm**  
35 x 31.1 x h 11.8 inch  
65 kg / 143.3 lb

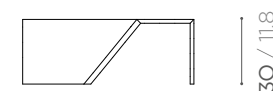
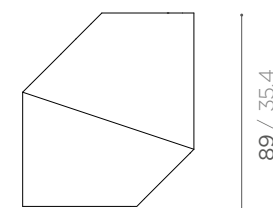

79 / 31.1



89 / 35.4

# ORIGAMI RAINBOW L COFFEE TABLE

EARTHQUAKE 5.9 COLLECTION - SPECIAL EDITION



ORIGAMI AMETHYST - COFFEE TABLE

DESCRIPTION

DIMENSIONS

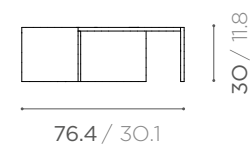
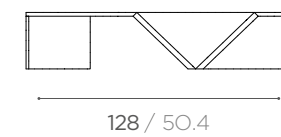
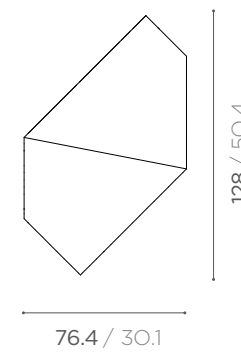

ORIGAMI COFFEE TABLE, FROM THE EARTHQUAKE 5.9 COLLECTION - SPECIAL RAINBOW ONYX EDITION.

BODY MADE ENTIRELY FROM A SINGLE, UNIQUE SLAB OF RAINBOW ONYX.

SIZE L.

**128 x 76,4 x h 30 cm**  
50.4 x 30.1 x h 11.8 inch  
81 kg / 178.6 lb

# ORIGAMI COFFEE TABLES MONO

EARTHQUAKE 5.9 COLLECTION



ORIGAMI COFFEE TABLES

DESCRIPTION

DIMENSIONS

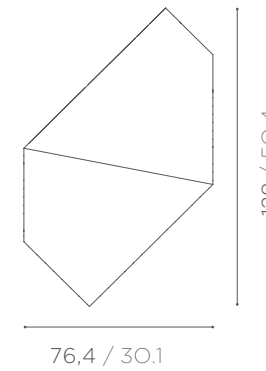

ORIGAMI MONO - STATUARIO

ORIGAMI COFFEE TABLE MADE FROM A SINGLE SLAB OF BIANCO STATUARIO MARBLE. SIZE L.

\*ALSO AVAILABLE IN SIZE S.

**128 x 76,4 x h 30 cm**  
50.4 x 30.1 x h 11.8 inch  
81 kg / 178.6 lb

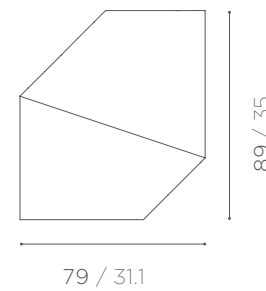

ORIGAMI MONO - GRAND ANTIQUE

ORIGAMI COFFEE TABLE MADE FROM A SINGLE SLAB OF GRAND ANTIQUE MARBLE. SIZE S.

\*ALSO AVAILABLE IN SIZE L.

**89 x 79 x h 30 cm**  
35 x 31.1 x h 11.8 inch  
65 kg / 143.3 lb

# ORIGAMI COFFEE TABLES BICOLOR

EARTHQUAKE 5.9 COLLECTION



O1



O2



O3



ORIGAMI COFFEE TABLES BICOLOR

DESCRIPTION

DIMENSIONS

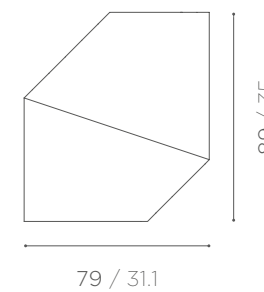

ORIGAMI BICOLOR O1

MARBLE BIANCO LASA AND VERDE ACQUAMARINA.  
SIZE S.

\*ALSO AVAILABLE IN SIZE L.

**89 x 79 x h 30 cm**  
35 x 31.1 x h 11.8 inch  
65 kg / 143.3 lb

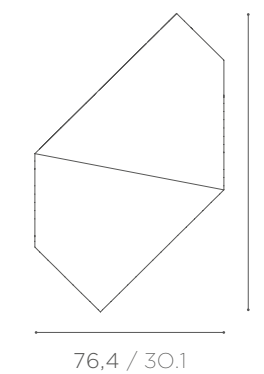

ORIGAMI BICOLOR O2

ORIGAMI TABLE MADE OF PINK ONYX AND NUVOLATO ONYX.  
SIZE L.

\*ALSO AVAILABLE IN SIZE S.

**128 x 76,4 x h 30 cm**  
50.4 x 30.1 x h 11.8 inch  
81 kg / 178.6 lb

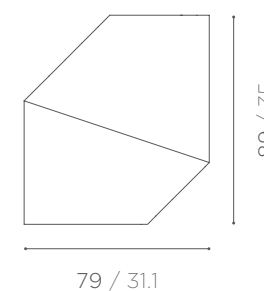

ORIGAMI BICOLOR O3

ORIGAMI TABLE MADE IN WHITE AND GREEN ONYX.  
SIZE S.

\*ALSO AVAILABLE IN SIZE L.

**89 x 79 x h 30 cm**  
35 x 31.1 x h 11.8 inch  
65 kg / 143.3 lb

# ORIGAMI STRIPES COFFEE TABLES

EARTHQUAKE 5.9 COLLECTION



ORIGAMI STRIPES COFFEE TABLES

DESCRIPTION

DIMENSIONS

(L)

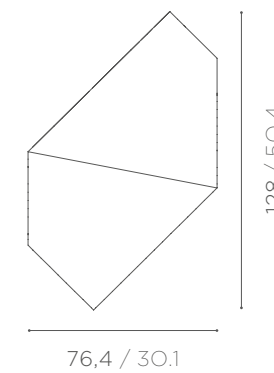

ORIGAMI STRIPES COFFEE TABLE L

POLYCHROME, INLAID ORIGAMI COFFEE TABLE, MADE OUT OF STRIPES OF PRECIOUS MARBLES AND ONYXES.  
SIZE L.

**128 x 76,4 x h 30 cm**  
50.4 x 30.1 x h 11.8 inch  
81 kg / 178.6 lb

(S)

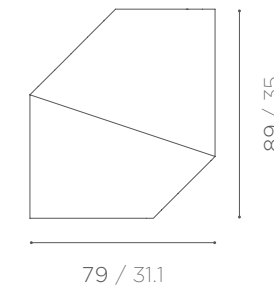

ORIGAMI STRIPES COFFEE TABLE S

POLYCHROME, INLAID ORIGAMI COFFEE TABLE, MADE OUT OF STRIPES OF PRECIOUS MARBLES AND ONYXES.  
SIZE L.

**89 x 79 x h 30 cm**  
35 x 31.1 x h 11.8 inch  
65 kg / 143.3 lb

# NAT|F|USE COFFEE TABLES O1-O2

NAT|F|USE COLLECTION



NAT|F|USE COFFEE TABLES

DESCRIPTION

DIMENSIONS

O1

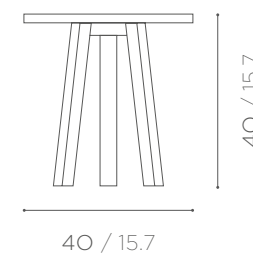

COFFEE TABLE O1

COFFEE TABLE WITH TOP MADE OF KNIT-TEXTURED AND EMBOSSED BIANCO CARRARA MARBLE, AND FLUO YELLOW BAND. TABLE FEET IN SPRUCE WOOD.

ø 40 x h 40 cm  
ø 15.7 x h 15.7 inch  
8 kg / 17,6 lb

O2

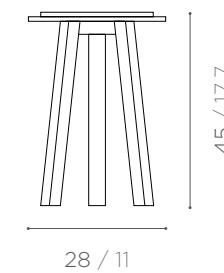

COFFEE TABLE O2

COFFEE TABLE WITH TOP MADE OF LIMESTONE CIRCULAR WITH EMBOSSED, KNITTED PATTERN. TABLE LEGS IN SPRUCE WOOD.

ø 28 x h 45 cm  
ø 11 x h 17.7 inch  
5 kg / 11 lb



PATRICIA URQUIOLA

COFFEE TABLES

# NAT|F|USE COFFEE TABLES O3-O4

NAT|F|USE COLLECTION



## NAT|F|USE COFFEE TABLES

### DESCRIPTION

### DIMENSIONS

O3

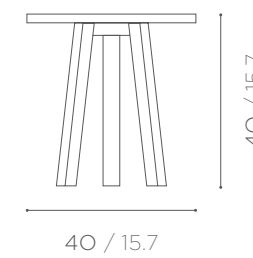

COFFEE TABLE O3

COFFEE TABLE WITH PIETRA SERENA  
OPENWORK TRICOT TOP.

ø 40 x h 40 cm  
ø 15.7 x h 15.7 inch  
8 kg / 17.6 lb

O4

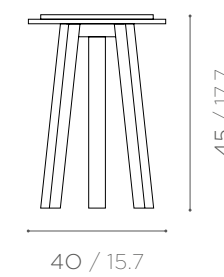

COFFEE TABLE O4

COFFEE TABLE WITH PIETRA SERENA  
TRICOT TOP.

ø 40 x h 45 cm  
ø 15.7 x h 17.7 inch  
8 kg / 17.6 lb



# ZIGZAG COFFEE TABLES

NAT|F|USE COLLECTION



ZIGZAG COFFEE TABLES

DESCRIPTION

DIMENSIONS

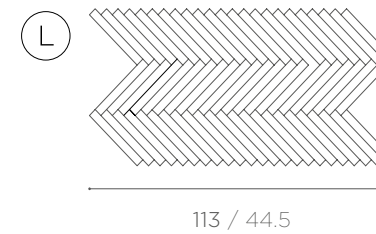

ZIGZAG COFFEE TABLE L

COFFEE TABLE MADE OF POLYCHROME MARBLE TILES INLAID IN A DYNAMIC PATTERN. TABLE FEET IN BLACK METAL. SIZE L.

**113 x 55 x h 34 cm**  
44.5 x 21.6 x h 13.4 inch  
35 kg / 77.2 lb

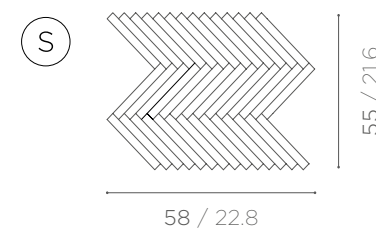

ZIGZAG COFFEE TABLE S

COFFEE TABLE MADE OF POLYCHROME MARBLE TILES INLAID IN A DYNAMIC PATTERN. TABLE FEET IN BLACK METAL. SIZE L.

**58 x 55 x h 39 cm**  
22.8 x 21.6 x h 15.3 inch  
18,3 kg / 40.4 lb

# BARRETTA COFFEE TABLES

NAT|F|USE COLLECTION



BARRETTA COFFEE TABLES

DESCRIPTION

DIMENSIONS

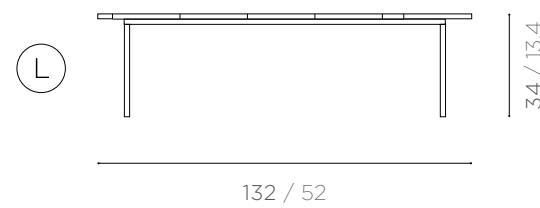

BARRETTA L

INLAID COFFEE TABLES MADE OF POLYCHROME PRECIOUS MARBLES AND ONYXES WITH A STRIPED PATTERN.

**132 x 33 x h 34 cm**  
52 x 13 x h 13.4 inch  
25 kg / 55.1 lb

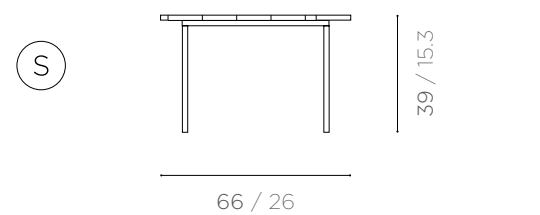

BARRETTA S

INLAID COFFEE TABLES MADE OF POLYCHROME PRECIOUS MARBLES AND ONYXES WITH A STRIPED PATTERN.

**66 x 36 x h 39 cm**  
26 x 14.2 x h 15.3 inch  
15 kg / 33 lb

# MAARTEN DE CEULAER

# SQUARE LOW COFFEE TABLE

PANTHEON COLLECTION



## SQUARE LOW COFFEE TABLE

## DESCRIPTION

## DIMENSIONS

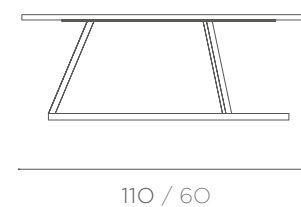

36 / 29.5

SQUARE LOW COFFEE TABLE, BACKGROUND IN BIANCO NUVOLA MARBLE, INNER CIRCLE IN AZUL SKY MARBLE. TABLE FEET IN SATIN AND BRUSHED GOLDEN METAL.

**110 x 110 x h 36 cm**  
**ø foot base 90 cm**

ø 60 x h 29.5 inch  
ø foot base 25 inch

113 kg / 249.1 lb

# GWENNAEL NICOLAS

# SHIKAKU COFFEE TABLE

FRAGMENT COLLECTION



SHIKAKU COFFEE TABLE

DESCRIPTION

DIMENSIONS

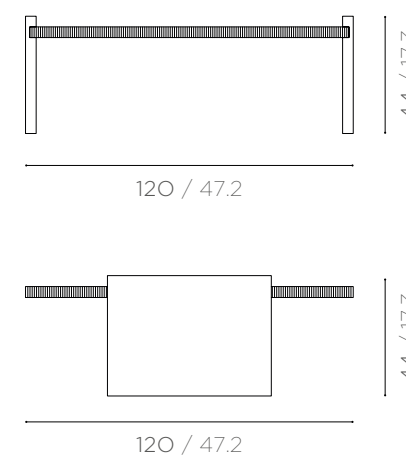

LOW SQUARE COFFEE TABLE WITH MARBLE STRIPED PATTERN IN SHADES OF BLUE AND GREEN. THE VIBRANT COMBINATIONS OF THE PRECIOUS VERDE LAPONIA, BARDIGLIO, VERDE CIPOLLINO, VERDE AQUAMARINA, LAPIS LAZULI, VERDE RAMEGGIATO, BIANCO NAMIBIA, STRIATO OLPICO AND BIANCO COVELANO MARBLES ENRICH THE INTERIOR OF AN ABSOLUTE PROTAGONIST.

**120 x 120 x h 44 cm**  
 47.2 x 47.2 x h 17.3 inch  
 86 kg / 189.6 lb

# TRITTICO-SAN COFFEE TABLES

FRAGMENT COLLECTION



TRITTICO-SAN COFFEE TABLE

DESCRIPTION

DIMENSIONS

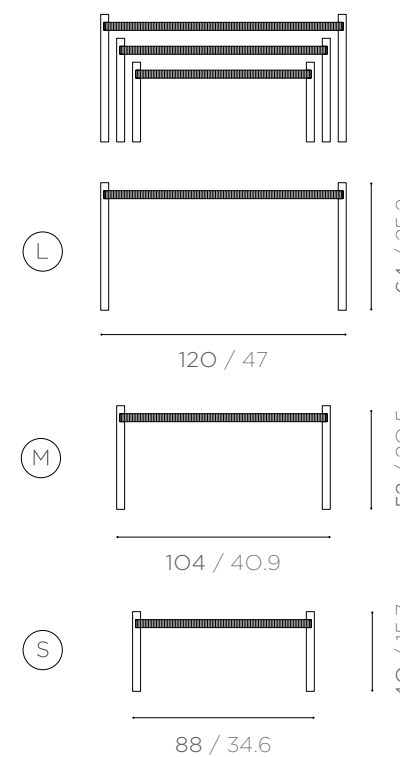

TRIPTYCH OF MODULAR COFFEE TABLES WITH STRIPED PATTERN IN MARBLE IN SHADES OF BLUE AND GREEN, SUCH AS VERDE LAPONIA, BARDIGLIO, VERDE CIPOLLINO, VERDE ACQUAMARINA, LAPIS LAZULI, VERDE RAMEGGIATO, BIANCO NAMIBIA, STRIATO OLIMPICO AND BIANCO COVELANO.

AVAILABLE IN THREE SIZES: S, M AND L.

| Size | Dimensions (cm / inch)                | Weight (kg)  |
|------|---------------------------------------|--------------|
| S    | 88 x 56 x h 40<br>34.6 x 22 x h 15.7  | weight 34 kg |
| M    | 104 x 56 x h 52<br>40.9 x 22 x h 20.5 | weight 44 kg |
| L    | 120 x 56 x h 64<br>47 x 22 x h 25.2   | weight 55 kg |

cm / inch

# BAKODO SIDE TABLES

FRAGMENT COLLECTION



(S)



(L)



## BAKODO SIDE TABLES

## DESCRIPTION

## DIMENSIONS

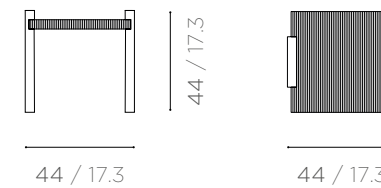

### BAKODO SIDE TABLE S

SIDE TABLE WITH STRIPED PATTERN IN MARBLE IN SHADES OF WHITE AND GRAY, WITH FEET MADE UP OF 4 SMALL SLABS COUPLED WITH DIFFERENT MATERIALS. MADE OF STRIATO OLIMPICO, BIANCO SIVEC, BIANCO NAMIBIA AND BIANCO COVELANO.

**44 x 44 x h 44 cm**  
17.3 x 17.3 x h 17.3 inch  
24 kg / 53 lb

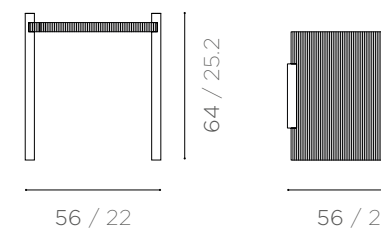

### BAKODO SIDE TABLE L

SIDE TABLE WITH STRIPED PATTERN IN MARBLE IN SHADES OF WHITE AND GRAY, WITH FEET MADE UP OF 4 SMALL SLABS COUPLED WITH DIFFERENT MATERIALS. MADE OF STRIATO OLIMPICO, BIANCO SIVEC, BIANCO NAMIBIA AND BIANCO COVELANO.

**56 x 56 x h 64 cm**  
22 x 22 x h 25.2 inch  
46 kg / 101.4 lb



# CALEIDOS COFFEE TABLES

MARMOR NATVM COLLECTION



CALEIDOS COFFEE TABLES

DESCRIPTION

DIMENSIONS

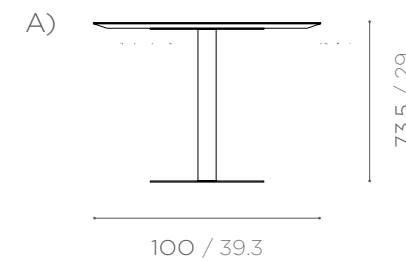
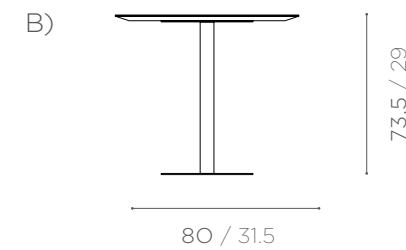

TABLE TOP IN ZEBRINO EXTRA WHITE MARBLE INLAY OR ZEBRINO SILVER MARBLE INLAY. TABLE LEG IN SHINY STAINLESS STEEL.

A) **Ø 100 x h 73,5 cm**  
 Ø 39,3 x h 29 inch  
 60 kg / 132.3 lb

AVAILABLE IN TWO DIFFERENT SIZES.



B) **Ø 80 x h 73,5 cm**  
 Ø 31,5 x h 29 inch  
 40 kg / 88.2 lb



GWENAEL NICOLAS

SIDE TABLES

# IUNGO SIDE TABLE

MARMOR NATVM COLLECTION



IUNGO SIDE TABLE

## DESCRIPTION

MODULAR COFFEE TABLE IN CALACATTA  
FOX MARBLE.

## DIMENSIONS

**132 x 132 x h 36 cm**  
52 x 52 x h 14.2 inch  
70 kg / 154.3 lb

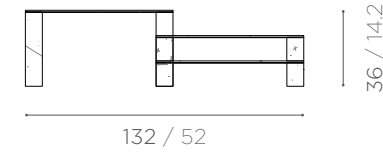

# CONTINUOUS SIDE TABLES & SHELF

MARMOR NATVM COLLECTION



CONTINUOUS SIDE TABLES & SHELF

DESCRIPTION

DIMENSIONS

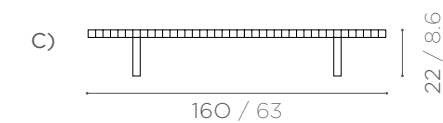
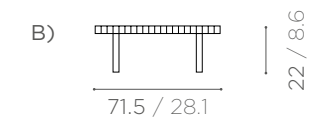
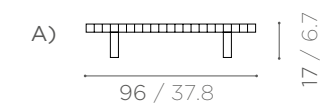

SIDE TABLES AND SHELF MADE OF INLAID STRIPES OF NERO MARQUINA AND STATUARIETTO MARBLE.

A, B) SIDE TABLES;  
C) SHELF.

A) **96 x 107 x h 17 cm**  
37.8 x 42 x h 6.7 inch  
120 kg / 264.5 lb

B) **71.5 x 107 x h 22 cm**  
28.1 x 42 x h 8.6 inch  
103 kg / 227 lb

C) **160 x 28 x h 22 cm**  
63 x 11 x h 8.6 inch  
55 kg / 121.2 lb

# SONJA VIZZINI



SONJA VIZZINI

SIDE TABLES

# VIRIL, VERIDIQUE, VENERABLE

VANITEUX COLLECTION

VIRIL



VENERABLE



VERIDIQUE



VANITEUX COLLECTION

DESCRIPTION

DIMENSIONS

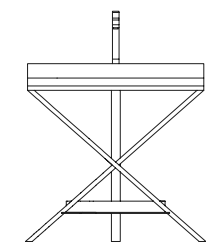

80 / 31.5

104 / 40.9

VIRIL

VERSATILE SINK CONSISTING OF THREE OVERLAPPING MARBLE TRAYS SUPPORTED BY PLIANT WITH BRUSHED COPPER FINISHING. THE INTERNAL NERO MARQUINIA MARBLE TRAY, POSES ON A ROSSO FRANCIA MARBLE TRAY. THE UNDERLYING TRAY IS IN GIALLO SIENA MARBLE.

**80 x 60 x h 104 cm**  
31.5 x 23.6 x h 40.9 inch  
45 kg / 99.2 lb

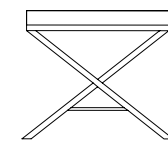

50 / 19.7

45 / 17.7

VERIDIQUE

VERSATILE TABLE A PLATEAU WITH NERO MARQUINIA MARBLE TRAY SUPPORTED BY PLIANT WITH BRUSHED BRASS FINISHING.

**50 x 30 x h 45 cm**  
19.7 x 11.8 x h 17.7 inch  
20 kg / 44.1 lb

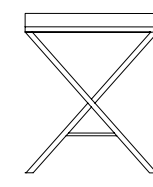

50 / 19.7

60 / 23.6

VENERABLE

VERSATILE TABLE A PLATEAU WITH SICILIAN JASPER TRAY SUPPORTED BY PLIANT WITH BRUSHED BRONZE FINISHING.

**50 x 45 x h 60 cm**  
19.7 x 17.8 x h 23.6 inch  
30 kg / 66.1 lb



# PATRICIA URQUIOLA

# ARCHITEXTURE CONSOLLE

ARCHITEXTURE COLLECTION



## ARCHITEXTURE CONSOLLE

## DESCRIPTION

## DIMENSIONS

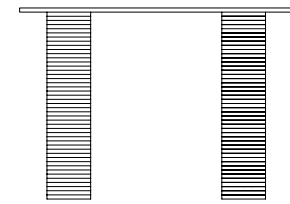

87,4 / 34.4

125 / 49.2

CONSOLLE WITH TWO STRIPED LEGS.  
AVAILABLE IN:

- ① TRAVERTINO ROMANO CLASSICO WITH OPEN PORE AND AQUAREL MANDARIN ONYX;
- ② NERO PORTORO AND TRAVERTINO CLASSICO ROMANO WITH OPEN PORE;

**125 x 45 x h 87,4 cm**  
49.2 x 17.7 x h 34.4 inch  
90 kg / 198 lb

## MATERIAL COMBINATIONS



①



②

TABLE TOP IN EXTRA CLEAR  
TEMPERED GLASS.



# MAREA CONSOLLE

AGUA COLLECTION



MAREA CONSOLLE

DESCRIPTION

DIMENSIONS

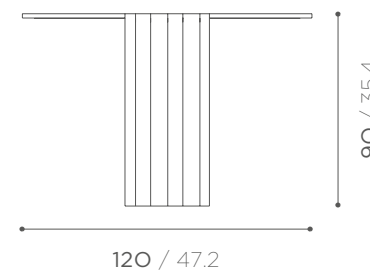

COMPOSED OF A BISCUIT-SHAPED TOP, INLAID WITH MARBLE IN PINK SHADES. AMONG THE MATERIALS USED: PINK QUARTZITE, SEQUOIA REDWOOD AND VERDE CIPOLLINO.

**120 x 37 x h 90 cm**  
47.2 x 14.6 x h 35.4 inch  
67 kg / 147.7 lb

# ORILLA CONSOLLE

AGUA COLLECTION



ORILLA CONSOLLE

DESCRIPTION

DIMENSIONS

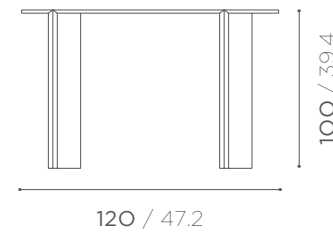

RECTANGULAR CONSOLLE WITH GEOMETRIC DESIGN, TOP AND LEGS IN VERDE ACQUAMARINA AND VERDE CIPOLLINO.

**120 x 40 x h 100 cm**  
47.2 x 15.7 x h 39.4 inch  
121 kg / 266.7 lb

# GWENNAEL NICOLAS

# SUBARASHI CONSOLLE

FRAGMENT COLLECTION



SUBARASHI CONSOLLE

DESCRIPTION

DIMENSIONS

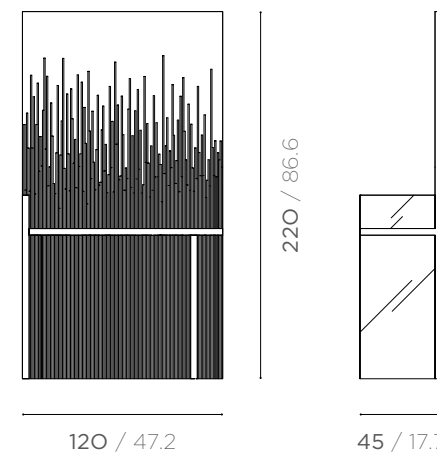

CONSOLLE COMPOSED OF A SELF-SUPPORTING POLYCHROME COVERING, WHOSE TOP AND FOOT ARE MADE OF MIRRORED METAL, CREATING A SURPRISING GRAPHIC CONTINUITY.

**120 x 45 x h 220 cm**  
47.2 x 17.7 x h 86.6 inch  
125 kg / 275.5 lb

MADE OF VERDE LAPONIA, VERDE ACQUAMARINA, VERDE CIPOLLINO, IRISH GREEN, VERDE RAMEGGIATO, VERDE ANTIGUA, VERDE MING, LAPIS LAZULI, AZUL BOQUIRA, AZUL MACAUBAS, ROSSO ALICANTE, ROUGE DE ROI, SEQUOIA RED, ROSA PORTOGALLO, GIALLO SIENA, GIALLO ANTICO, BARDIGLIO, TOBACCO BROWN, PALISSANDRO, ZEBRINO.

# SETIS CONSOLLE

MARMOR NATVM COLLECTION



ERUPTIO



CICATRIX



SETIS CONSOLLE

DESCRIPTION

DIMENSIONS

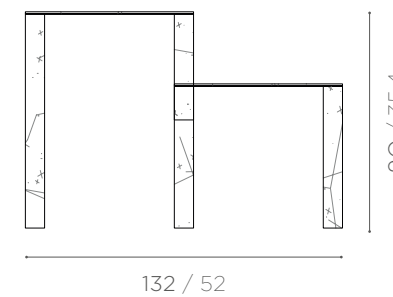

SETIS "ERUPTIO" CONSOLLE  
CONSOLLE IN CALACATTA FOX WITH NERO  
MARGUINA MARBLE INLAYS.

**132 x 36 x h 90 cm**  
52 x 14.1 x h 35.4 inch  
86,4 kg / 190.5 lb

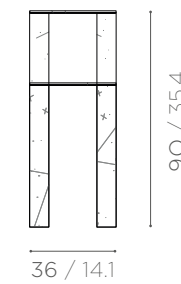

SETIS "CICATRIX" CONSOLLE  
CONSOLLE IN CALACATTA FOX WITH NERO  
MARGUINA MARBLE INLAYS.

**132 x 36 x h 90 cm**  
52 x 14.1 x h 35.4 inch  
86,4 kg / 190.5 lb



# PATRICIA URQUIOLA

# AGATA CARPET

AGUA COLLECTION



AGATA CARPET

DESCRIPTION

DIMENSIONS

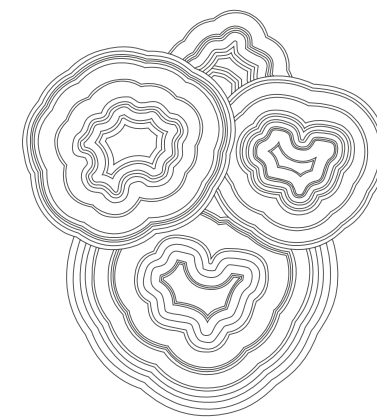

367,4 / 144,6

326,7 / 128,6

AGATA, A SPECTACULAR CARPET MADE OF FINE VARIETIES OF MARBLE AND ONYX, IN MARINE SHADES OF BLUE AND GREEN. A LARGE-SCALE SIMULATION OF AGATES, ARRANGED TO CREATE SINUOUS GEOMETRIC PATTERNS. A CARPET THAT IS THE CENTREPIECE OF A SPACE.

**367,4 x 326,7 cm**  
144.6 x 128.6 inch  
476 kg / 1050 lb



# NAT|F|USE CARPET

NAT|F|USE COLLECTION



NAT|F|USE CARPET

DESCRIPTION

DIMENSIONS

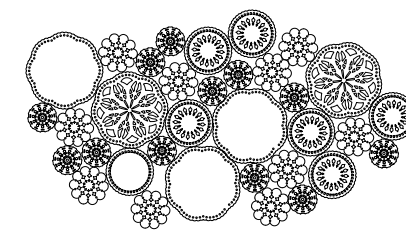

130 / 51.8

250 / 98.4

CARPET MADE OF MARBLE AND LIMESTONE LACES HELD TOGETHER BY A FLUO YELLOW BAND. AVAILABLE IN TWO SIZES.

- A) **250 x 130 cm**  
98.4 x 51.8 inch  
THICKNESS 2 cm / 0.8 INCH
- B) **140 x 140 cm**  
51.1 x 51.1 inch  
THICKNESS 2 cm / 0.8 INCH



# PATRICIA URQUIOLA

# SEMICIRCLES BENCH & STOOL

NAT|F|USE COLLECTION

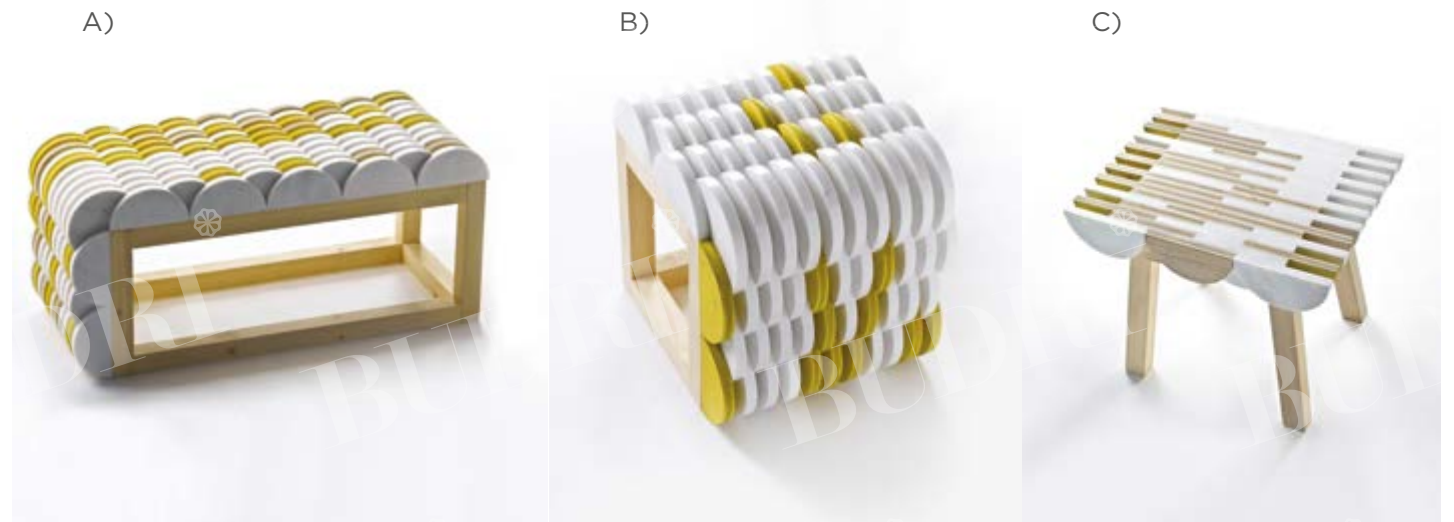
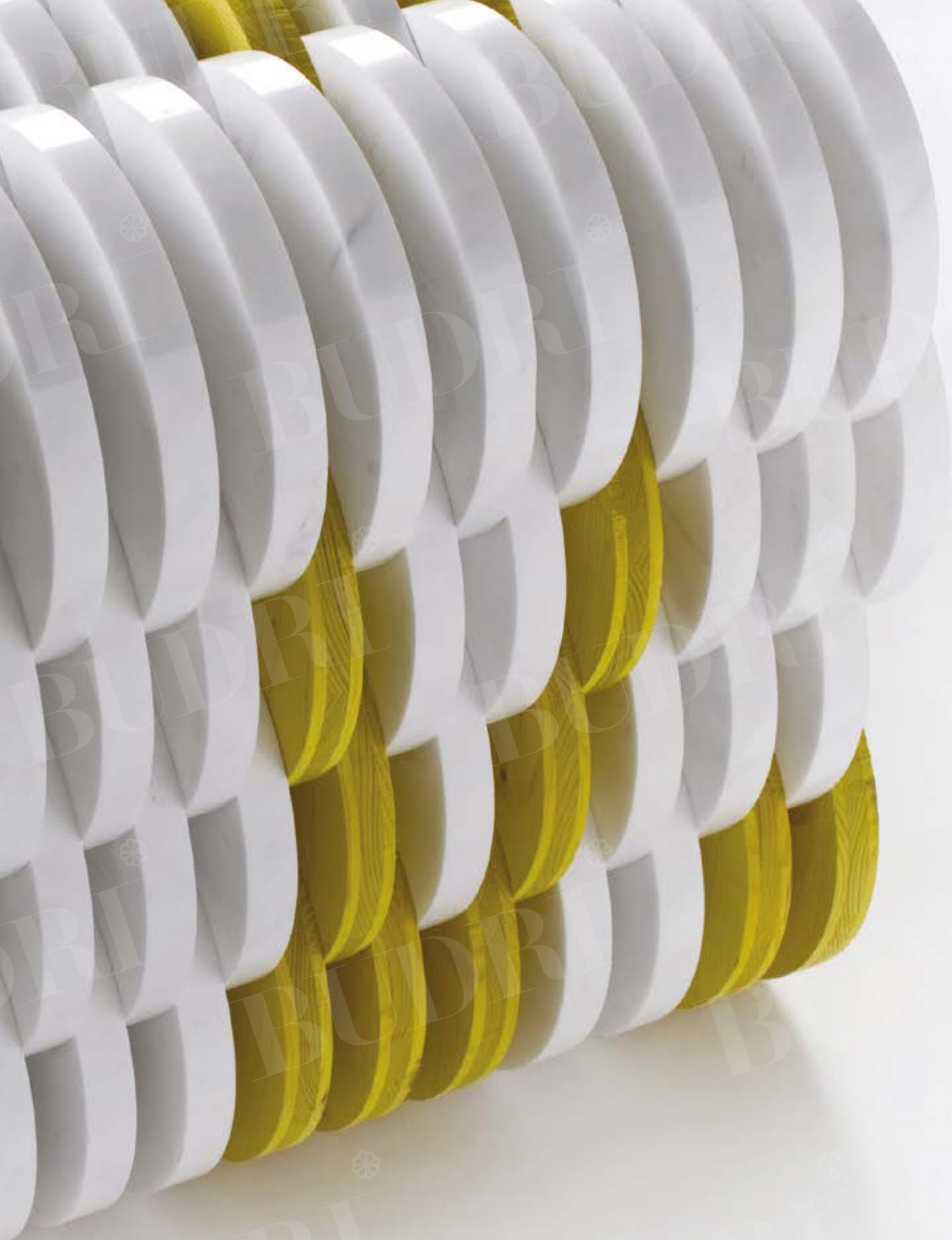

SEMICIRCLES SEATS

DESCRIPTION

DIMENSIONS

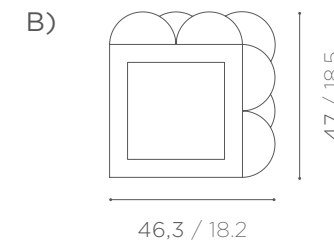

**SEMICIRCLES BENCH**  
 BENCH WITH SEMICIRCLES IN BIANCO LASA MARBLE, AND SPRUCE WOOD WITH FLUO YELLOW PAINT FINISH. INNER FRAME IN SPRUCE WOOD.

AVAILABLE IN TWO SIZES.

- A) **110 x 40 x h 47 cm**  
43.3 x 15.7 x h 18.5 inch  
65 kg / 143.3 lb
- B) **46,3 x 40 x h 47 cm**  
18.2 x 15.7 x h 18.5 inch  
42 kg / 92.6 lb

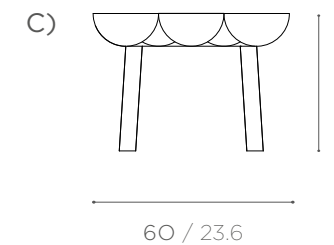

**SEMICIRCLES STOOL**  
 STOOL WITH SEMICIRCLES IN BIANCO LASA MARBLE, AND SPRUCE WOOD WITH FLUO YELLOW PAINT FINISH. FEET IN SPRUCE WOOD.

- C) **60 x 42 x h 45 cm**  
23.6 x 16.5 x h 17.7 inch  
21 kg / 46.3 lb



PATRICIA URQUIOLA

SEATS

# FACHIRO BENCH

MARBLELACE COLLECTION



## FACHIRO BENCH

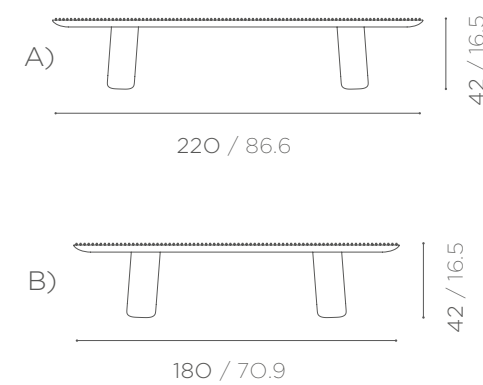

## DESCRIPTION

BENCH IN LIGHT POLISHED BIANCO CARRARA MARBLE WITH SOLID BISCUIT FEET AND 'PIXEL' EMBOSSED TEXTURE.

AVAILABLE IN TWO SIZES.

## DIMENSIONS

A) **220 x 49,5 x h 42 cm**  
86.6 x 19.5 x h 16.5 inch  
145 kg / 319.7 lb

B) **180 x 44,5 x h 42 cm**  
70.9 x 17.5 x h 16.5 inch  
116 kg / 255.7 lb

# ALGAE BENCH

MACROSTERIAS COLLECTION

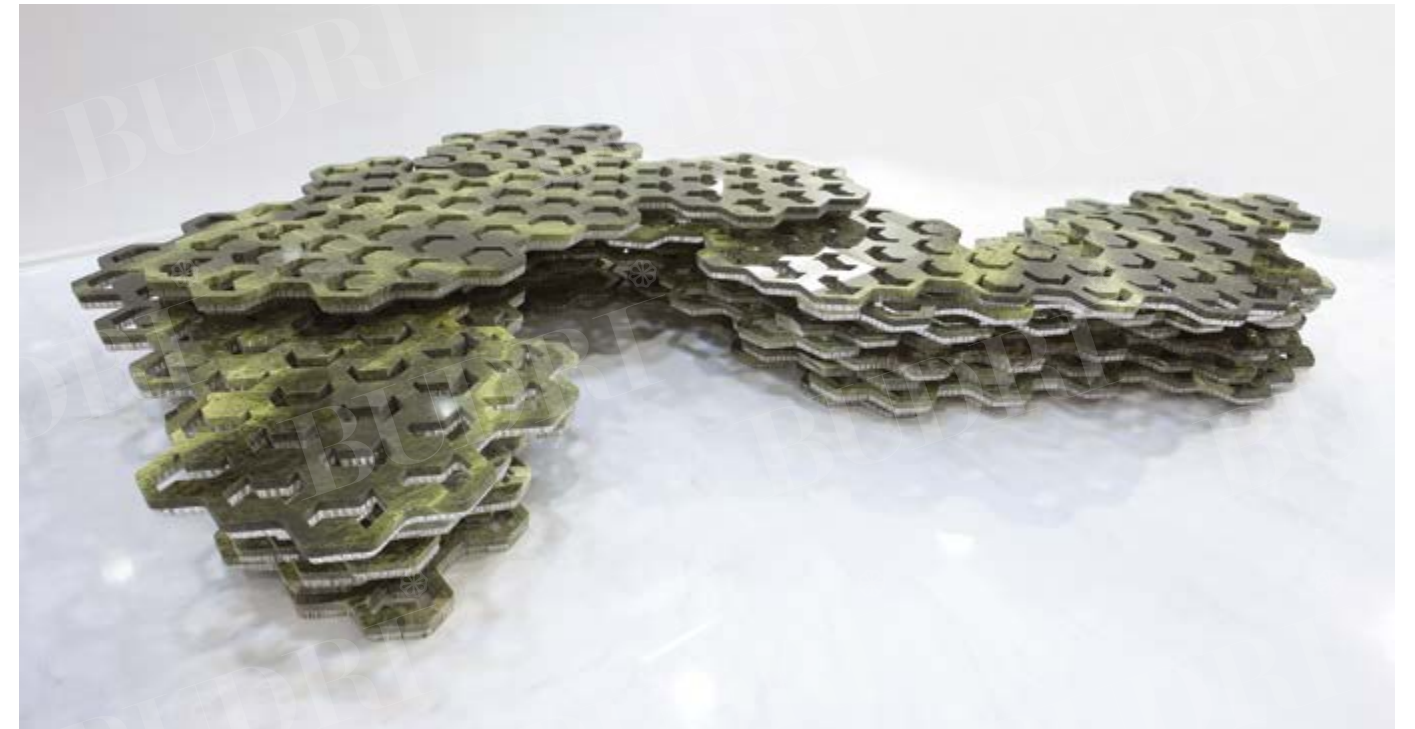
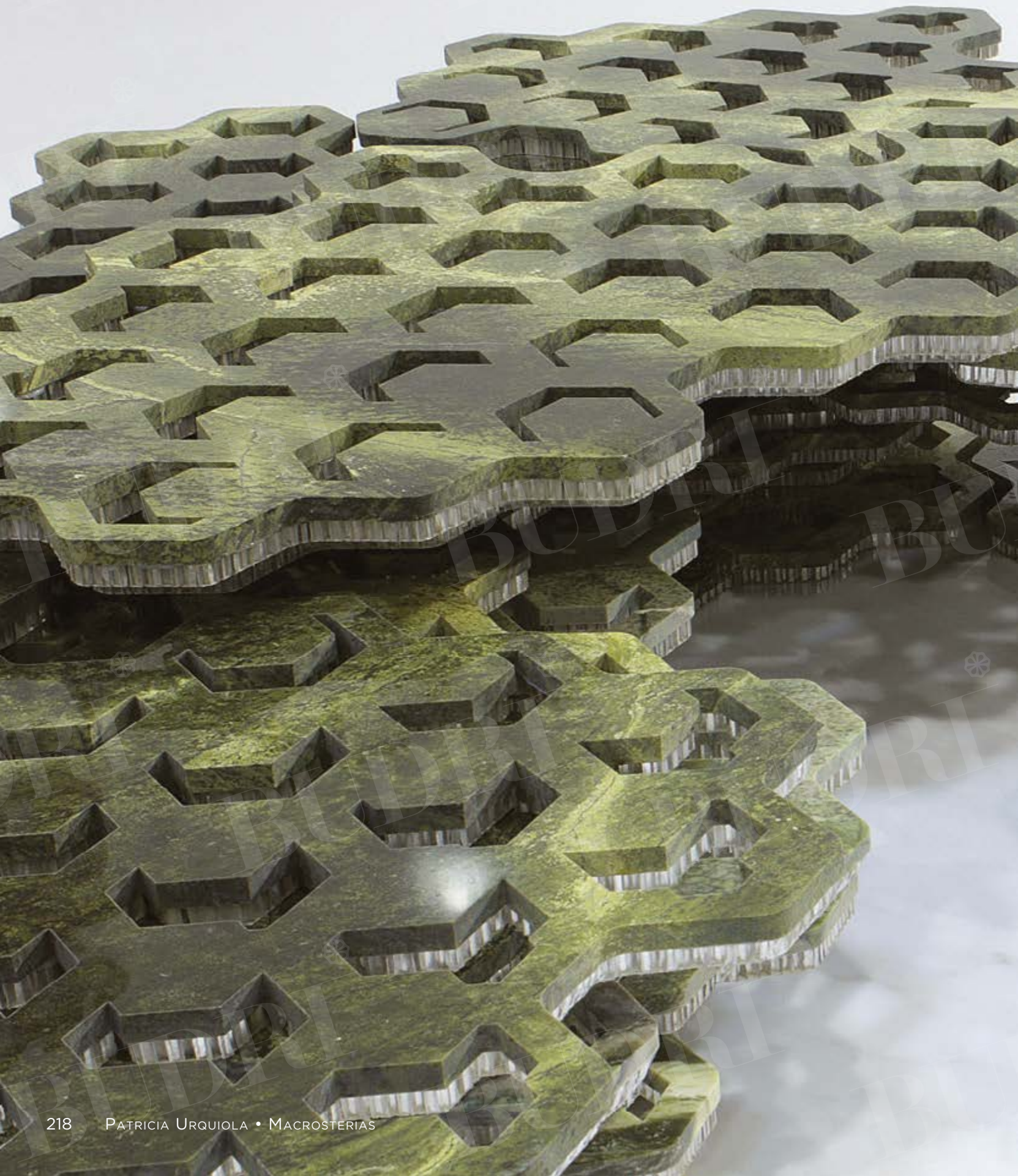

## ALGAE BENCH

## DESCRIPTION

## DIMENSIONS

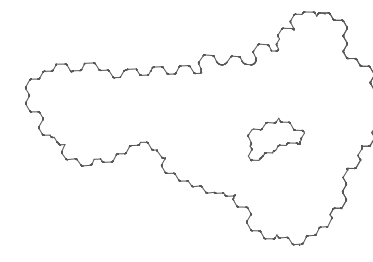

GIANT BENCH (40 SQUARE METRES) IN GREEN BOWENITE INLAID WITH HONEYCOMB.

**408 x 263 x h 90 cm**  
160.6 x 103.5 x h 35.4 inch

# SIDEBOARDS

# GWENNAEL NICOLAS



# EXQUISITUS SIDEBOARD

MARMOR NATVM COLLECTION



## EXQUISITUS SIDEBOARD

## DESCRIPTION

## DIMENSIONS



54 / 21.3

240 / 94.5

SIDEBOARD WITH STORAGE IN BIANCO NAMIBIA AND NERO BELGIO MARBLE INLAY.

**240 x 50,5 x h 54 cm**  
94.5 x 20 x h 21.3 inch  
300 kg / 661.3 lb



# PATRICIA URQUIOLA

# BOOKCASE DISPLAY

RABBIT COLLECTION



BOOKCASE DISPLAY

DESCRIPTION

DIMENSIONS

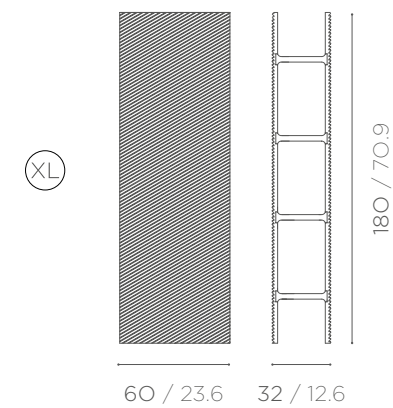

**BOOKCASE DISPLAY XL**  
 BOOKCASE DISPLAY CONSISTING OF A SOLID BLOCK OF LIGHT AZUL MACAUBAS WITH RIDGED TEXTURE AND ROSA PORTOGALLO SHELVES.

**32 x 60 x h 180 cm**  
 12.6 x 23.6 x h 70.9 inch  
 215 kg / 474 lb

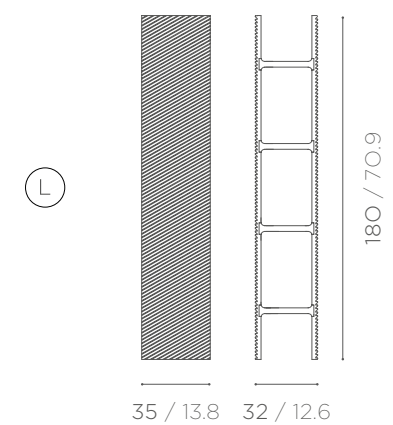

**BOOKCASE DISPLAY L**  
 BOOKCASE DISPLAY CONSISTING OF A SOLID BLOCK OF LIGHT AZUL MACAUBAS WITH RIDGED TEXTURE AND ROSA PORTOGALLO SHELVES.

**32 x 35 x h 180 cm**  
 12.6 x 13.8 x h 70.9 inch  
 150 kg / 330.6 lb

# BOOKCASE DISPLAY

RABBIT COLLECTION

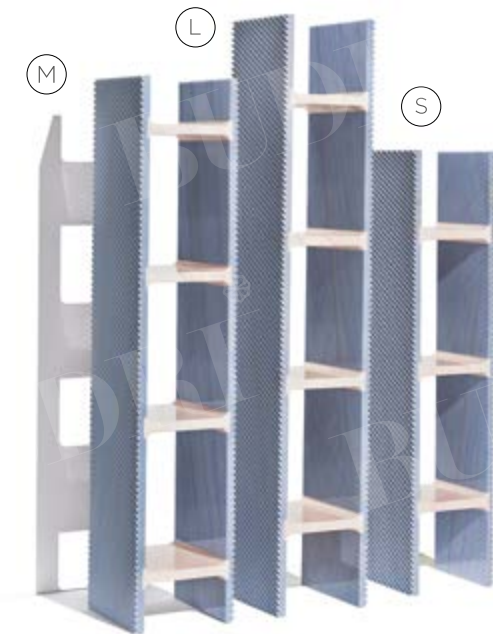

BOOKCASE DISPLAY

DESCRIPTION

DIMENSIONS

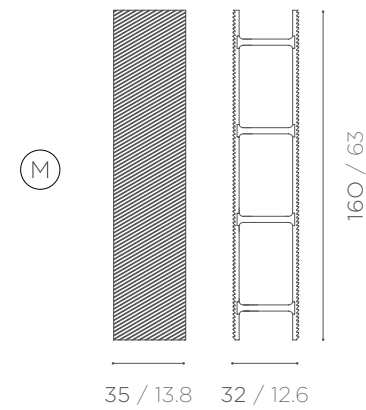

**BOOKCASE DISPLAY M**

BOOKCASE DISPLAY CONSISTING OF A SOLID BLOCK OF LIGHT AZUL MACAUBAS WITH RIDGED TEXTURE AND ROSA PORTOGALLO SHELVES.

**32 x 35 x h 160 cm**  
12.60 x 13.78 x h 63 inch  
135 kg / 297.6 lb

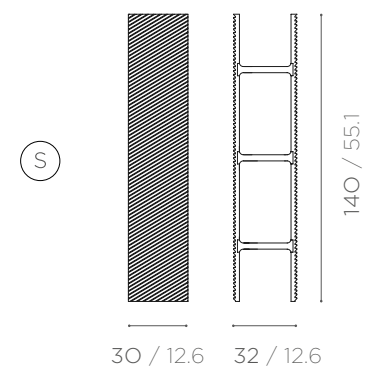

**BOOKCASE DISPLAY S**

BOOKCASE DISPLAY CONSISTING OF A SOLID BLOCK OF LIGHT AZUL MACAUBAS WITH RIDGED TEXTURE AND ROSA PORTOGALLO SHELVES.

**32 x 30 x h 140 cm**  
12.6 x 11.8 x h 55.1 inch  
114 kg / 251.3 lb

# SHELF WALL DISPLAY

RABBET COLLECTION

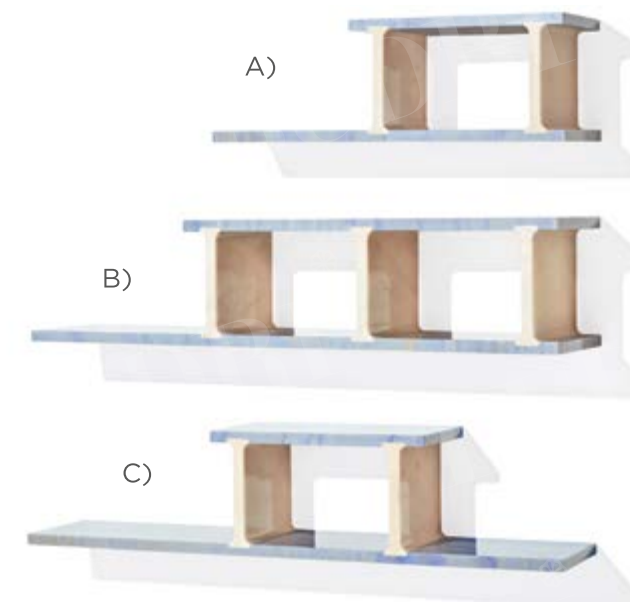

SHELF / WALL DISPLAY

DESCRIPTION

DIMENSIONS

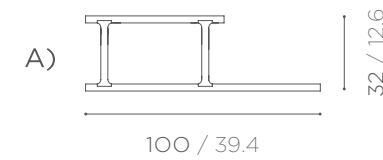

SHELF / WALL DISPLAY  
SHELF IN LIGHT AZUL MACAUBAS AND ROSA PORTOGALLO. TYPE A.

**100 x 32 x h 30 cm**  
39.4 x 12.6 x h 11.8 inch  
47,3 kg / 104.2 lb

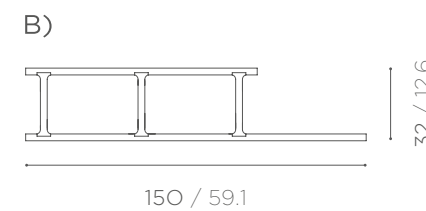

SHELF / WALL DISPLAY  
BOOKCASE IN LIGHT AZUL MACAUBAS AND ROSA PORTOGALLO. TYPE B.

**150 x 32 x h 30 cm**  
59.1 x 12.6 x h 11.8 inch  
73,7 kg / 162.5 lb

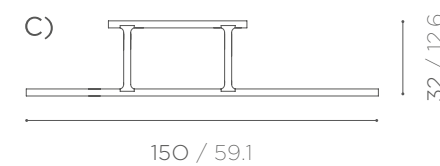

SHELF / WALL DISPLAY  
SHELF IN LIGHT AZUL MACAUBAS AND ROSA PORTOGALLO. TYPE C.

**150 x 32 x h 30 cm**  
59.1 x 12.6 x h 11.8 inch  
58,5 kg / 128.9 lb

# GWENNAEL NICOLAS



GWENAEL NICOLAS

BOOKCASES

# FLUO BOOKCASE

MARMOR NATVM COLLECTION



FLUO BOOKCASE

## DESCRIPTION

BOOKCASE IN FUMÈ ASHWOOD WITH SLIDING PANELS IN CALACATTA FOX AND NERO MARQUINA MARBLE INLAYS.

## DIMENSIONS

**260 x 50 x h 300 cm**  
102.3 x 19.6 x h 118.1 inch  
585 kg / 1289.7 lb

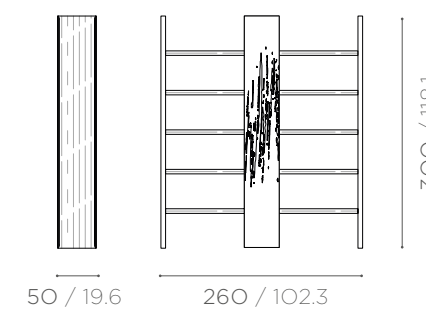





# PATRICIA URQUIOLA



# PARAVENT SCREEN

AQUAREL COLLECTION



PARAVENT SCREEN

DESCRIPTION

DIMENSIONS

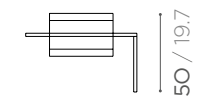
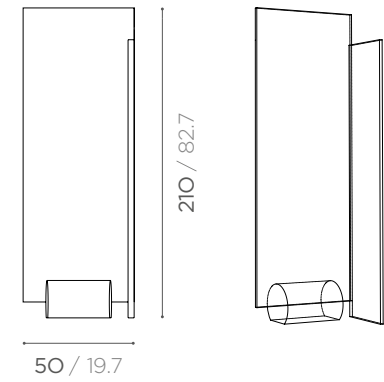

AQUAREL PARAVENT IS A MODULAR SCREEN FORMED BY AN ALTERNATION OF AN ELEMENTS MADE FROM SLABS OF IRANIAN SUNSET AQUAREL WHITE ONYX AND SLABS OF OPEN-PORE TRAVERTINO CLASSICO ROMANO MARBLE, SUPPORTED BY CYLINDERS IN THE SAME MATERIAL.

**50 x 50 x h 210 cm**  
 19.7 x 19.7 x h 82.7 inch  
 180 kg / 396,8 lb

# WASH BASIN

RABBET COLLECTION



## WASH BASIN

## DESCRIPTION

## DIMENSIONS

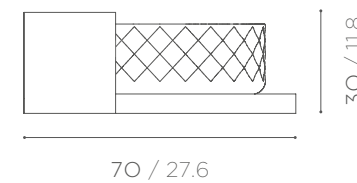

WASH BASIN PRODUCED FROM A SOLID BLOCK OF ROSA PORTOGALLO WITH MATELASSÉ FINISH.

**70 x 41 x h 30 cm**  
27.6 x 16.1 x h 11.8 inch  
55 kg / 36.8 lb

THE COUNTERTOP SUPPORTING THE WASH BASIN IS IN BARDIGLIO, WITH OUTER CASING IN METAL WITH COPPER-COLOURED COATING.

# GWENNAEL NICOLAS



GWENAEL NICOLAS

OTHERS

# ESSENTIAL DIFFUSER

MARMOR NATVM COLLECTION



## ESSENTIAL DIFFUSER

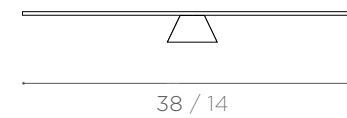

## DESCRIPTION

FRAGRANCE DIFFUSER IN NERO MARQUINA MARBLE. SCENTED STICKS NOT INCLUDED.

## DIMENSIONS

Ø 38 cm  
Ø 14 inch  
2.5 kg / 17.6 lb

# GLOBUS CHANDELIER

MARMOR NATVM COLLECTION



## GLOBUS CHANDELIER

## DESCRIPTION

## DIMENSIONS

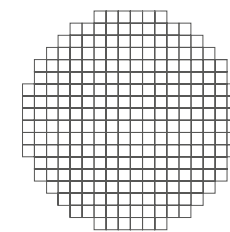

180 / 70.9

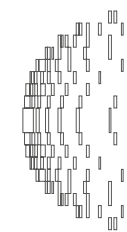

89.6 / 35.3

SCULPTURAL CHANDELIER MADE OF HUNDREDS OF TESSERAE OF "PANDA WHITE" MARBLE.

Ø 180 x 89.6 cm  
Ø 70.9 x 35.3 inch

# LIQUIDUS MIRROR

MARMOR NATVM COLLECTION



## LIQUIDUS MIRROR

## DESCRIPTION

## DIMENSIONS

MIRROR WITH MARBLE INLAYS IN NERO MARQUINA OR STATUARIETTO MARBLE.

**48 x 200 cm**  
18.8 x 78.7 inch  
45 kg / 99.2 lb

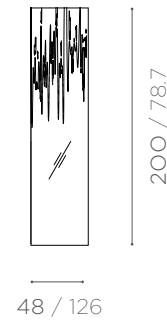



VALERIO COMETTI  
& CODICE ICONA

  
CODICEICONA

Design by

**VALERIO  
COMETTI  
+V12DESIGN**

In collaboration with

**BUDRI**

laboratorioaudio



VALERIO COMETTI & CODICE ICONA

OTHERS

# FERMAT

MARBLE SPEAKER & DOCKING STATION

VERDE ALPI



CALACATTA



ROSSO LEVANTO

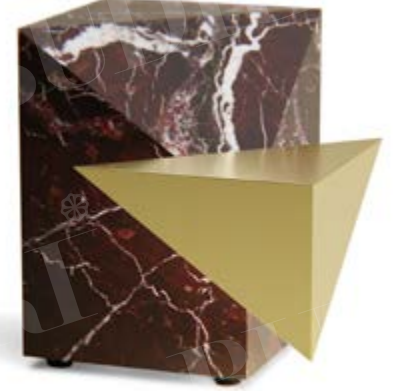

## FERMAT

## DESCRIPTION

## DIMENSIONS

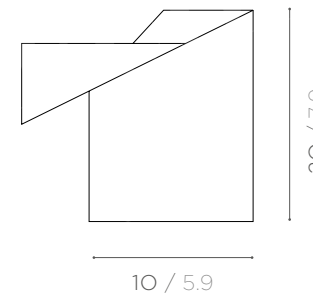

EXCLUSIVE SPEAKER AND MOBILE PHONE DOCKING STATION WITH A CURTESY LIGHT.

AVAILABLE IN VERDE ALPI, CALACATTA, OR ROSSO LEVANTO FINISH.

**10 x 10 x h 20 cm**  
5.9 x 5.9 x h 7.9 inch  
5,8 kg / 12.7 lb



# GWENNAEL NICOLAS

# WANDO FLOOR LAMP

FRAGMENT COLLECTION



WANDO FLOOR LAMP

DESCRIPTION

FLOOR LAMP MADE UP OF RODS OF DIFFERENT HEIGHTS AND THICKNESSES, IN PRECIOUS POLYCHROME MARBLES SUCH AS LAPPONIA GREEN, GIALLO SIENA, RUPAS RED, LAPIS LAZULI, EMERALD GREEN, SIVEC WHITE, BLACK MARGUINA AND AZUL MACAUBAS.

LAMP BASE IN MIRROR-FINISHED METAL.

DIMENSIONS

ø base 40 cm  
ø body 20 cm  
h 150 cm

ø base 15.7 inch  
ø body 7.9 inch  
h 59 inch

65 kg / 143.3 lb

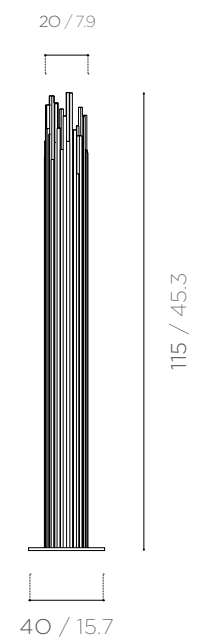

# GUTTA LAMP

MARMOR NATVM COLLECTION



GUTTA LAMP

DESCRIPTION

DIMENSIONS

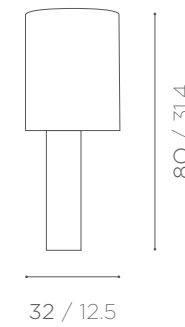

TABLE LAMP IN "BIANCO STATUARIO" WITH NERO MARQUINA MARBLE INLAYS AND VICE-VERSA.

**32 x 80 cm**  
12,5 x 31.4 inch  
16 kg / 35.2 lb





GWENAEL NICOLAS

LIGHTING

# THINIUM WALL LAMP

MARMOR NATVM COLLECTION



## THINIUM WALL LAMP

## DESCRIPTION

## DIMENSIONS

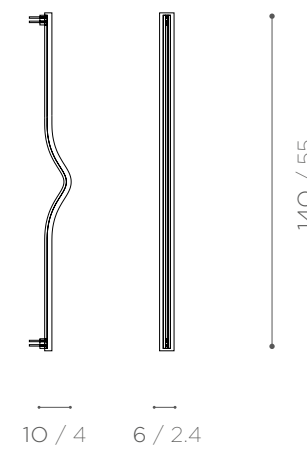

WALL LAMP IN BENDED STATUARIETTO MARBLE.

**6 x 10 x h 140 cm**  
2.4 x 4 x h 55 inch  
5,6 kg / 12.3 lb



# CRISTINA CELESTINO



## ALICE LAMP



BLACKWOOD



VERDE ANTIGUA



SARRANCOLIN VERSAILLES



ALICE LAMP

DESCRIPTION

DIMENSIONS

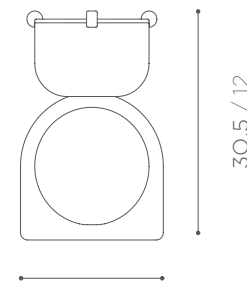

19,5 / 7,7

30,5 / 12

TABLE LAMP WITH DIMMABLE LIGHT AND TOUCH CONTROLS.

AVAILABLE IN VERDE ANTIGUA, SARRANCOLIN VERSAILLES, BLACKWOOD MARBLE BODY.

LAMP IN WHITE OR PINK ONYX.

**19,5 x 18 x h 30,5 cm**  
7.7 x 7.1 x h 12 inch  
5 kg / 11 lb

# ABOUT BUDRI

# STEADY GROWTH



SINCE 1960, BUDRI HAS SPECIALISED IN WORKING FINE MARBLES AND NATURAL STONES. NOW AN ESTABLISHED COMPANY OF WORLD-CLASS RENOWN, BUDRI CONTINUES TO ENJOY STEADY GROWTH, WITH A MANUFACTURING FACILITY OF 8000 M<sup>2</sup>.

AVAILING OF OVER 60 YEARS' EXPERIENCE IN BUSINESS, BUDRI SETS THE BENCHMARK FOR THE DESIGN, BESPOKE EXECUTION AND INSTALLATION OF MAJOR PROJECTS OF GREAT COMPLEXITY IN ALL FIVE CONTINENTS. THE BRAND OCCUPIES A PRIVILEGED POSITION IN NICHE MARKETS WITH HIGH ADDED VALUE, CHARACTERISED BY SUPERIOR PRODUCT QUALITY, BESPOKE PROJECTS AND AN OUTSTANDING LEVEL OF SERVICE DEDICATED TO CLIENTS. BUDRI IS THE IDEAL PARTNER FOR PROJECTS THAT REQUIRE ITALIAN EXCELLENCE IN CRAFTSMANSHIP, CUTTING-EDGE TECHNOLOGIES AND AN IMPRESSIVE PRODUCTION CAPACITY.

# WORLDWIDE

BUDRI CREATIONS ARE INSTALLED BY THE COMPANY'S OWN LAYING TEAMS IN ALL FIVE CONTINENTS.

## AUSTRALIA

- › PRIVATE VILLA, MELBOURNE

## AZERBAIJAN

- › PRIVATE VILLA, BAKU

## BAHREIN

- › PRIVATE VILLA, MANAMA

## CAMBODIA

- › PRIVATE VILLA, PHNOM PENH

## CHINA

- › PRIVATE VILLA BEJING D 18
- › PIAGET, SHENZEN
- › GIVENCHY, SHENZEN

## CONGO

- › DOMAINE PRESIDENTIEL

## CROATIA

- › HOTEL BRIIG, SPLIT

## CZECH REPUBLIC

- › LOUIS VUITTON, PRAGUE

## ECUADOR

- › PRIVATE VILLA FOR THE ITALIAN EMBASSY QUITO

## EGYPT

- › PRIVATE VILLA, CAIRO
- › 3 HOLIDAY CRUISERS «THE QUEEN OF THEBES» LUXOR

## FRANCE

- › HOTEL MARTINEZ, CANNES
- › PRIVATE APARTMENT AV. MONTAINGNE, PARIS
- › PRIVATE VILLA, ANTIBES
- › CARTIER, CANNES
- › SERGIO ROSSI, PARIS
- › GIAN VITO ROSSI, PARIS
- › DOLCE & GABBANA PARIS

- › DOLCE & GABBANA, CANNES
- › PRIVATE VILLA, CAP FERRAT
- › PRIVATE VILLA, ROQUEBRUNE

## GERMANY

- › BORIS FUCHSMANN'S RESIDENCE, DÜSSELDORF
- › OBERMEIEER BAEDER, GMBH
- › PRIVATE VILLA, BERLIN
- › LOUIS VUITTON BOUTIQUE, BERLIN
- › MARIENTURM SUITE LOUNGE BAR, FRANKFURT
- › BMW DESIGN WELT, MUENCHEN

## GREECE

- › MR. COSTANTINO'S LEGAL OFFICES, ATHENS
- › PRIVATE CRUISER FOR GOLDEN SHIPMANAGEMENT LTD. VOULIAGMENI

## HONG KONG

- › GIVENCHY BOUTIQUE HONG KONG
- › PRIVATE VILLA AND OFFICE MOUNT NICHOLSON HONG KONG
- › PRIVATE VILLA, HONG KONG

## HUNGARY

- › GRAND ROYAL HOTEL CORINTHIA BUDAPEST
- › PRIVATE VILLA, BUDAPEST

## INDONESIA

- › PRIVATE VILLA, JAKARTA
- › MONCLER BOUTIQUE SINGAPORE

## IRELAND

- › 4 FITNESS CENTRES FOR «INTERNATIONAL LEISURE GROUP» DUBLIN

## ISRAEL

- › PRIVATE VILLA, TEL AVIV
- › PRIVATE VILLA, CESAREA
- › PRIVATE APARTMENT, TEL AVIV

## ITALY

- › VILLA ALESSANDRINI, MODENA
- › 7 PRIVATE VILLAS COSTA SMERALDA, SARDINIA

- › ALGHERO AIRPORT, SARDINIA
- › GRAND HOTEL «MOLINO STUCKY», VENICE
- › HOTEL FOUR SEASONS, MILAN
- › LOUIS VUITTON BOUTIQUE, VENICE
- › LOUIS VUITTON BOUTIQUE, ROME
- › GIAN VITO ROSSI BOUTIQUE, MILAN

- › SANTONI BOUTIQUE, MILAN
- › DOLCE & GABBANA, VENICE

- › GIEVENCHY, ROME
- › DOLCE & GABBANA, ROME

- › DOLCE & GABBANA, VIA DELLA SPIGA MILAN

- › DOLCE & GABBANA, CORSO VENEZIA MILAN

- › LOUIS VUITTON BOUTIQUE, MILAN
- › MONCLER BOUTIQUE, MILAN

- › PRIVATE VILLA, PORTOFINO
- › TOD'S BOUTIQUE, VIA MONTE NAPOLEONE MILAN

- › PRIVATE YACHT "REGINA D'ITALIA" CODECASA F74 VIAREGGIO

- › PRIVATE APARTAMENT, FIORI OSCURI MILAN
- › PRIVATE APARTAMENT, VIA FRATELLI GABBA MILAN

- › PRIVATE APARTAMENT, VIA DELLA MOSCOVA MILAN

- › PRIVATE APARTAMENT, VIA TASSO MILAN

- › PRIVATE APARTAMENT, PIAZZA CASTELLO MILANO

- › PRIVATE APARTAMENT, VIA BIGLI MILANO
- › PRIVATE VILLA, FORTE DEI MARMI

- › PRIVATE VILLA, PORTOFINO

- › PRIVATE VILLA, SANTA MARGHERITA LIGURE

- › LOUIS VUITTON, FORTE DEI MARMI
- › PRIVATE VILLA, SELVA DI VAL GARDENA
- › PRIVATE VILLA, PESCARA

## JAPAN

- › HERMÈS BOUTIQUE TAKASHIMAYA
- › OSAKA AIRPORT

- › HERMÈS BOUTIQUE KÖBE

- › HERMÈS BOUTIQUE SHIN

- › DOLCE & GABBANA OSAKA

## KUWAIT

- › LOUIS VUITTON BOUTIQUE KUWAIT CITY

## MALDIVES

- › RESORT VELAA, MALDIVES

## MONTENEGRO

- › PRIVATE VILLA, MONTENEGRO

## NIGERIA

- › PRIVATE VILLA LAGOS

## NORWAY

- › LOUIS VUITTON OSLO

## PALESTINE

- › HOTEL CASINO, JERICO

## PRINCIPALITY OF MONACO

- › DOLCE & GABBANA, MONTE CARLO
- › MONCLER BOUTIQUE, MONTECARLO

## QATAR

- › PRIVATE VILLA «HER ROYAL HIGHNESS THE PRINCESS OF QATAR», DOHA
- › GIVENCHY, DOHA
- › DOLCE & GABBANA KID, DOHA
- › DOLCE & GABBANA, DOHA

## RUSSIA

- › COMPLEX OF 6 PRIVATE VILLAS AND WELLNESS CENTRE, MOSCOW
- › RESIDENTIAL AND BUSINESS CENTRE KOPERNIKO, MOSCOW
- › PRIVATE VILLA, ST. PETERSBURG
- › PRIVATE VILLA GB GROUP NAZAROVO
- › PRIVATE APARTAMENT, MOSCOW
- › PRIVATE VILLA NOVOSIBIRSK, SIBERIA
- › TIFFANY MOSCOW
- › LOUIS VUITTON BOUTIQUE ST. PETERSBURG
- › PRIVATE VILLA ST. PETERSBURG

## SAUDI ARABIA

- › PRIVATE VILLA FOR SAUDI EMIR RIYADH

## SPAIN

- › PRIVATE VILLA «L. D.» MARBELLA
- › PRIVATE VILLA «L.» MARBELLA
- › PRIVATE VILLA «M.» MARBELLA
- › PRIVATE VILLA «G.» MARBELLA
- › PRIVATE VILLA «B.» MARBELLA
- › PRIVATE VILLA MARBELLA
- › LOUIS VUITTON BOUTIQUE, BARCELONA

## QATAR

- › PRIVATE VILLA «HER ROYAL HIGHNESS THE PRINCESS OF QATAR», DOHA
- › GIVENCHY, DOHA
- › DOLCE & GABBANA KID, DOHA
- › DOLCE & GABBANA, DOHA

## RUSSIA

- › COMPLEX OF 6 PRIVATE VILLAS AND WELLNESS CENTRE, MOSCOW
- › RESIDENTIAL AND BUSINESS CENTRE KOPERNIKO, MOSCOW
- › PRIVATE VILLA, ST. PETERSBURG
- › PRIVATE VILLA GB GROUP NAZAROVO
- › PRIVATE APARTAMENT, MOSCOW
- › PRIVATE VILLA NOVOSIBIRSK, SIBERIA
- › TIFFANY MOSCOW
- › LOUIS VUITTON BOUTIQUE ST. PETERSBURG
- › PRIVATE VILLA ST. PETERSBURG

## SAUDI ARABIA

- › PRIVATE VILLA FOR SAUDI EMIR RIYADH

## SPAIN

- › PRIVATE VILLA «L. D.» MARBELLA
- › PRIVATE VILLA «L.» MARBELLA
- › PRIVATE VILLA «M.» MARBELLA
- › PRIVATE VILLA «G.» MARBELLA
- › PRIVATE VILLA «B.» MARBELLA
- › PRIVATE VILLA MARBELLA
- › LOUIS VUITTON BOUTIQUE, BARCELONA

## SOUTH KOREA

- › PRIVATE PLACE OF WORSHIP SEUL

## SWITZERLAND

- › PRIVATE VILLA «AL HANA», GENÈVE
- › HOTEL «LA RESERVE», GENÈVE
- › ATLANTIS HOTEL, ZURICH
- › PRIVATE ATTIC FLOOR, ZURICH
- › PRIVATE VILLA, LUGANO

## TURKEY

- › LOUIS VUITTON BOUTIQUE, INSTANBUL

## UKRAINE

- › PRIVATE VILLA, KIEV

## UNITED ARAB EMIRATES

- › SHEIKH ZAYED BIN SULTAN AL NAHYAN MOSQUE, ABU DHABI
- › DOLCE & GABBANA, DUBAI
- › LOUIS VUITTON BOUTIQUE, ABU DHABI

## UNITED KINGDOM

- › PRIVATE VILLA FOR SAUDI EMIR HYDE PARK, LONDON
- › PRIVATE VILLA FOR SAUDI EMIR SAINT GEORGE, LONDON
- › PRIVATE VILLA FOR SAUDI EMIR CHARLES STREET, LONDON
- › PRIVATE VILLA FOR FPPM PARIS SAINT KEAN, LONDON
- › GREENWICH PARK BAR & GRILL FOR GREENWICH INC., LONDON
- › FLOS-MOROSO SHOWROOM, LONDON
- › SHIZARU GALLERY 112 MOUNT ST MAYFAIR, LONDON
- › PRIVATE VILLA «DEBENHAM HOUSE», LONDON
- › PRIVATE VILLA MAYFAIR, LONDON
- › PRIVATE VILLA HOLLAND PARK, LONDON
- › PRIVATE MANSION MAYFAIR, LONDON
- › BENTLEY HOME BOUTIQUE, LONDON
- › DOLCE & GABBANA LONDON
- › LOUIS VUITTON BOUTIQUE LONDON
- › MSGM BOUTIQUE, LONDON
- › MONCLER BOUTIQUE, LONDON
- › CANALI, LONDON

## USA

- › CASINO HOTEL WYNN LAS VEGAS
- › GOLF CLUB, MIAMI
- › PRIVATE VILLA, NEW YORK
- › GIAN VITO ROSSI BOUTIQUE, NEW YORK
- › PRIVATE VILLA, SAN FRANCISCO
- › DOLCE & GABBANA, MIAMI
- › MONCLER BOUTIQUE, NEW YORK
- › DOLCE & GABBANA, DALLAS
- › DOLCE & GABBANA, LAS VEGAS
- › MONCLER BOUTIQUE, CHICAGO
- › PRIVATE VILLA, BEVERLY HILLS

# COLLABORATIONS

\_BULGARI

\_CARTIER

\_CÉLINE

\_DOLCE & GABBANA

\_FENDI CASA

\_FRATELLI ROSSETTI

\_GESSI

\_GIANVITO ROSSI

\_GIVENCHY

\_HERMÉS

\_LOUIS VUITTON

\_MONCLER

\_MSGM

\_PRADA

\_SANTONI

\_SERGIO ROSSI

\_TIFFANY & Co.

# AWARDS & ACCOLADES

2010 AWARDS: BEST COMMUNICATOR AWARD WITH MARBLE LACE, DESIGNED BY PATRICIA URQUIOLA

2011 AWARDS: BEST COMMUNICATOR AWARD WITH NATFUSE, DESIGNED BY PATRICIA URQUIOLA

2012 AWARDS: ELLE DECOR INTERNATIONAL DESIGN AWARD - BEST WALL CLADDING

2012 BUDRI PRODUCES THE AWARD FOR "GRAZIA BEST BAG", PRESENTED TO KARL LAGERFELD (DESIGN P. URQUIOLA)

2015 AWARDS: MARMOMACC BEST COMMUNICATOR AWARD 2015 WITH PAPIRO COLLECTION, DESIGNED BY PATRICIA URQUIOLA

2017 HORIZON 2020 SLIM INNOVATION

2017 ADI DESIGN INDEX 2017 BUDRI MARBLE EYEWEAR

## CO-AWARDS

2018 WALLPAPER DESIGN AWARD 2018 - DOLCE & GABBANA LONDON - PROJECT BY CURIOSITY - BUDRI BESPOKE MARBLE SUPPLY

## BUDRI S.R.L.

FACTORY & HEADQUARTERS  
VIA DI MEZZO 65  
41037 MIRANDOLA (Mo) - ITALY

T +39 0535 21967

INFO@BUDRI.COM

## BUDRI MILANO

SHOW-ROOM ENTRANCE  
FORO BUONAPARTE 60  
20121 MILANO - ITALY

T +39 02 87252558  
BUDRIMILANO@BUDRI.COM

## BUDRI SWITZERLAND SA

LEGAL OFFICE:  
VIA SASS CURONA 1  
6900 LUGANO BREGANZONA - SWITZERLAND

T +41 91 9733049  
INFO@BUDRI.CH

## BUDRI LONDON LTD

5TH FLOOR, NORTH SIDE  
7-10 CHANDOS STREET - LONDON  
W1G 9DQ

T +44 (0)207 631 2061  
INFO@BUDRI.UK

 @BUDRIITALIANMARBLEINLAY  
 @BUDRI\_OFFICIAL

BUDRI.COM  
MESTIERIGRUPPO.COM

A  MESTIERI COMPANY